

AlterPath PM Installation, Administration, and User's Guide

Software Version 1.7.1



Cyclades Corporation

3541 Gateway Boulevard
Fremont, CA 94538 USA
1.888.CYCLADES (292.5233)
1.510.771.6100
1.510.771.6200 (fax)
<http://www.cyclades.com>
Release Date: October 2005
Part Number: PAC0216

©2005 Cyclades Corporation

Information in this document is subject to change without notice. The following are registered or registration-pending trademarks of Cyclades Corporation: Cyclades and AlterPath.

All trademarks, trade names, logos and service marks referenced herein, even when not specifically marked as such, belong to their respective companies and are not to be considered unprotected by law.

Contents

| | |
|---|-----------|
| Before You Begin | xv |
| Audience | xvi |
| Document Organization | xvii |
| Related Documents | xviii |
| Typographic and Other Conventions | xix |
| | |
| Chapter 1: Introduction | 1 |
| Description | 2 |
| Alarms and Monitoring | 2 |
| Sequential Power Up | 2 |
| Support for Daisy Chaining | 2 |
| Creation of User Accounts | 3 |
| Integration with Cyclades Management Products | 3 |
| Hardware Configuration Options | 4 |
| Standalone Configuration | 4 |
| Daisy-chained Configuration | 5 |
| Integrated Configuration | 6 |
| Accessing the System Console | 8 |
| Direct Console Access | 8 |
| Console Access through a Management Device | 9 |
| Models and Components | 9 |
| AlterPath PM8 | 10 |
| AlterPath PM8i | 11 |
| AlterPath PM10 | 12 |
| AlterPath PM10i | 13 |

| | |
|---|-----------|
| AlterPath PM10i-L30A | 14 |
| AlterPath PM10i-32A | 14 |
| AlterPath PM10i-32Au | 15 |
| AlterPath PM20 | 15 |
| AlterPath PM20i | 16 |
| AlterPath PM20i 32A | 17 |
| AlterPath PM20i 32Au | 17 |
| | |
| Chapter 2: Installation | 19 |
| Gathering Required Equipment | 20 |
| Reviewing the Shipping Box Contents | 20 |
| Modular Input Power Cables for the AlterPath PM | 22 |
| AlterPath PM8i-15A and AlterPath PM10i-10A Power Cables | 23 |
| AlterPath PM10i-15A Power Cables | 24 |
| AlterPath PM10i-16A and AlterPath PM 20i-16A Power Cables | 24 |
| AlterPath PM10i-20A and AlterPath PM 20i-20A Power Cables | 25 |
| Optional Outlet Cable Package | 26 |
| Setting Up the AlterPath PM | 26 |
| Installation Environment | 27 |
| Daisy Chaining PMs | 31 |
| Plugging Devices Into AlterPath PM Outlets | 32 |
| Powering On the AlterPath PM | 32 |
| Making a Direct Connection for Console Access | 33 |
| | |
| Chapter 3: Configuration..... | 37 |
| Default Configuration Parameters | 38 |
| Initial Configuration Using the Command Prompt | 38 |
| Resetting the Admin Password | 41 |
| Upgrading the AlterPath PM Firmware | 43 |
| | |
| Chapter 4: Command Line Interface | 49 |
| PM User Interface | 50 |
| Commands | 52 |
| adduser | 53 |
| alarm | 53 |

| | |
|-------------------------|----|
| assign | 54 |
| buzzer status | 55 |
| current | 56 |
| currentprotection | 57 |
| cycle | 58 |
| deluser | 59 |
| exit | 60 |
| factory_defaults | 61 |
| help | 62 |
| id | 64 |
| interval | 65 |
| list | 66 |
| lock | 67 |
| name | 67 |
| off | 69 |
| on | 70 |
| passwd | 70 |
| reboot | 71 |
| restore | 74 |
| save | 75 |
| status | 76 |
| syslog | 77 |
| temperature | 78 |
| unassign | 79 |
| unlock | 80 |
| ver | 80 |
| whoami | 81 |

Appendix A: Specifications 83

| | |
|--|----|
| Electrical and Hardware Specifications | 84 |
| Interface Pinouts | 96 |

Appendix B: Safety Instructions 97

| | |
|-------------------------------|-----|
| Safety Instructions | 98 |
| Sicherheitsanweisungen | 99 |
| Istruzioni di Sicurezza | 100 |

| | |
|----------------------------------|-----|
| Instruções de Segurança | 102 |
| Instrucciones de seguridad | 103 |
| Instructions de sécurités | 105 |
| FCC Warning Statement | 106 |
| Canadian DOC Notice | 106 |

Appendix C: Circuit Breakers 107

| | |
|---|-----|
| PM Units with One Circuit Breaker | 108 |
| PM8i and PM10i | 108 |
| PM10-L30A | 109 |
| PM10i-L30A | 110 |
| PM10i-32A and PM10i-32Au | 111 |
| PM20-L30A | 111 |
| PM20i-L30A | 112 |
| PM20i-32A and PM20i-32Au | 113 |
| Circuit Breaker Trip Time | 114 |

Index 115

Figures

| | | |
|---------------------|--|-----|
| Figure 1-1: | Standalone Configuration | 4 |
| Figure 1-2: | Daisy-chained Configuration..... | 5 |
| Figure 1-3: | The AlterPath PM with a Cyclades Management Device | 7 |
| Figure 1-4: | AlterPath PM8 | 10 |
| Figure 1-5: | AlterPath PM8i | 11 |
| Figure 1-6: | AlterPath PM10 | 12 |
| Figure 1-7: | AlterPath PM10i Back | 13 |
| Figure 1-8: | AlterPath PM10i Front | 13 |
| Figure 1-9: | The AlterPath PM20 | 15 |
| Figure 1-10: | The AlterPath PM20i..... | 16 |
| Figure 2-11: | Rack Mounting Holes on the AlterPath PM..... | 29 |
| Figure 2-12: | Rack Mount for the AlterPath PM8i..... | 30 |
| Figure 2-13: | Connecting a Local Work Station to the AlterPath PM..... | 33 |
| Figure C-1: | PM10-L30A Circuit Breakers | 109 |
| Figure C-2: | PM10i-L30A Circuit Breakers | 110 |
| Figure C-3: | PM20-L30A Circuit Breakers | 112 |
| Figure C-4: | PM20i-L30A Circuit Breakers | 113 |

Tables

| | | |
|--------------------|---|----|
| Table 2-2: | AlterPath PM8i-15A and AlterPath PM10i-10A Cables..... | 23 |
| Table 2-3: | AlterPath PM10i-15A | 24 |
| Table 2-4: | AlterPath PM10i-16A and AlterPath PM 20i-16A..... | 24 |
| Table 2-5: | AlterPath PM10i-20A and AlterPath PM 20i-20A..... | 25 |
| Table 2-6: | AlterPath PM Optimum Installation Environment | 27 |
| Table A-1: | PM8-15A Specifications..... | 84 |
| Table A-2: | PM8-20A and PM8-L20A Specifications | 85 |
| Table A-3: | PM8i-10A Specifications | 86 |
| Table A-4: | PM10-15A Specifications..... | 86 |
| Table A-5: | PM10-20A and PM10-L20A Specifications | 87 |
| Table A-6: | PM10-L30A Specifications | 87 |
| Table A-7: | PM10i-10A Specifications | 88 |
| Table A-8: | PM10i-15A Specifications | 88 |
| Table A-9: | PM10i-16A Specifications | 89 |
| Table A-10: | PM10i-20A Specifications | 90 |
| Table A-11: | PM10i-32A and PM10i-32Au Specifications..... | 90 |
| Table A-12: | PM10i-L30A Specifications | 91 |
| Table A-13: | PM20-20A and PM20-L20A Specifications | 92 |
| Table A-14: | PM20-L30A Specifications | 92 |
| Table A-15: | PM20i-16A Specifications | 93 |
| Table A-16: | PM20i-20A and PM20i-L20A Electrical Specifications..... | 94 |

| | | |
|--------------------|--|-----|
| Table A-17: | PM20i-L30A Specifications | 94 |
| Table A-18: | PM20i-32A and PM20i-32Au Specifications..... | 95 |
| Table C-20: | Circuit Breaker Trip Time | 114 |

Procedures

| | |
|---|----|
| ▼ To Mount the AlterPath PM8i, PM10, or PM10i | 29 |
| ▼ To Daisy Chain a PM..... | 31 |
| ▼ To Plug Devices Into AlterPath PM Outlets..... | 32 |
| ▼ To Power On the AlterPath PM..... | 32 |
| ▼ To Access the Console..... | 34 |
| ▼ To Log Into the AlterPath PM Through the Console (In Port)..... | 35 |
| ▼ To Change the Default Password..... | 39 |
| ▼ To Create Users Using the adduser Command..... | 39 |
| ▼ To Assign Outlets to Users Using the assign Command | 40 |
| ▼ To Name the Outlets Using the name Command | 40 |
| ▼ To Save the Configuration Using the save Command..... | 40 |
| ▼ To Reset the Admin Password Using the Loopback Connector..... | 41 |
| ▼ To Upgrade PM Firmware | 43 |

Commands

| | |
|-------------------------|----|
| adduser | 53 |
| alarm | 53 |
| assign | 54 |
| buzzer status | 55 |
| current | 56 |
| currentprotection | 57 |
| cycle | 58 |
| deluser | 59 |
| exit | 60 |
| factory_defaults | 61 |
| help | 62 |
| id | 64 |
| interval | 65 |
| list | 66 |
| lock | 67 |
| name | 67 |
| off | 69 |
| on | 70 |
| passwd | 70 |
| reboot | 71 |
| restore | 74 |
| save | 75 |
| status | 76 |
| syslog | 77 |
| temperature | 78 |
| unassign | 79 |
| unlock | 80 |

| | |
|-------------|----|
| ver | 80 |
| whoami..... | 81 |

Before You Begin

This installation, administration, and user's guide provides background information and procedures for installing, configuring, and maintaining the Cyclades AlterPath™ family of Power Management IPDUs (intelligent power distribution units):

- AlterPath PM8-15A
- AlterPath PM8-20A
- AlterPath PM8-L20A
- AlterPath PM8i-10A
- AlterPath PM10-15A
- AlterPath PM10-20A
- AlterPath PM10-L20A
- AlterPath PM10-L30A
- AlterPath PM10i-10A
- AlterPath PM10i-15A
- AlterPath PM10i-16A
- AlterPath PM10i-20A
- AlterPath PM10i-32A
- AlterPath PM10i-32Au
- AlterPath PM20-20A
- AlterPath PM20-L20A
- AlterPath PM20-L30A
- AlterPath PM20i-16A
- AlterPath PM20i-20A

Audience

- AlterPath PM20i-30A
- AlterPath PM20i-30Au
- AlterPath PM20i-L30A

This guide offers procedures for a stand-alone configuration. If you are integrating your PM with a Cyclades KVM or console management device, please see the related installation instructions for that product.

Audience

This manual is intended for installers and system administrators of the AlterPath PM and for users who may be authorized to manage power through the AlterPath PM. It assumes that the reader understands networking basics and is familiar with the terms and concepts used in Local and Wide Area Networking.

This document describes configuration, administration, and use of the AlterPath PM only. It does not describe how to set up and administer other external services or servers that the AlterPath PM may access.

Document Organization

The document contains the chapters listed in the following table.

Table P-1: Document Organization

| Chapter Number and Title | Description |
|--|---|
| Chapter 1: Introduction | Defines and explains the overall product features and uses of the AlterPath PM. |
| Chapter 2: Installation | Explains the procedures for installing the AlterPath PM in addition to explaining how to daisy chain AlterPath PMs. |
| Chapter 3: Configuration | Explains the procedures for performing basic configuration through a console connection to the AlterPath PM. |
| Chapter 4: Command Line Interface | Explains how to use the command line interface and offers syntax, arguments, and examples for each available command. |
| Appendix A: Specifications | Offers detailed electrical and hardware information on each PM model. |
| Appendix B: Safety Instructions | Provides important safety information for installing and operating the AlterPath PM. |
| Appendix C: Circuit Breakers | Explains how the circuit breakers work for each PM model. |
| Index | Provides a way to look up terms. In the online version of this manual, clicking the terms in the index brings you to where they are used in the manual. |

Related Documents

Updated versions of this document will be posted on the downloads section of the Cyclades website in the “AlterPath PM” section when Cyclades releases new versions of the software.

A printed version of this document can be ordered under part number OST0000-U00 through your Cyclades sales representative.

The following document for the Cyclades AlterPath PM is shipped with the product.

- *AlterPath PM Quick Start Guide (hard-copy)*

The following manuals for Cyclades AlterPath products mentioned in this guide are on the Documentation CD shipped with the product, and they are also available at <http://www.cyclades.com/docs> under their products’ names.

- *AlterPath Manager E2000 Manual*
- *AlterPath ACS Advanced Administration Guide*
- *AlterPath ACS User’s Guide*
- *Cyclades-TS User Guide*
- *AlterPath OnSite Installation, Administration, and User’s Guide*
- *AlterPath KVM/net Plus Installation, Configuration, and User’s Guide*
- *AlterPath KVM/net Installation, Configuration, and User’s Guide*
- *AlterPath KVM Installation, Configuration, and User’s Guide*

Printed versions of this document and all the above listed documents can be ordered from your Cyclades sales representative.

Updated versions of this document will be posted at the Cyclades website when Cyclades releases new versions of the software. See “Additional Resources” on page xx for information about free software upgrades.

Typographic and Other Conventions

The following table describes the typographic conventions used in Cyclades manuals.

Table P-2: Typographic Conventions

| Typeface | Meaning | Example |
|---------------------|--|--|
| <u>Links</u> | Hypertext links or URLs | Go to: http://www.cyclades.com |
| <i>Emphasis</i> | Titles, emphasized or new words or terms | See the <i>AlterPath AlterPath PM Quick Start</i> . |
| Filename or Command | Names of commands, files, and directories; onscreen computer output. | Edit the <code>pslave.conf</code> file. |
| User type | What you type in an example, compared to what the computer displays | <code>pm>alarm</code> |

The following table describes other terms and conventions.

Table P-3: Other Terms and Conventions

| Term or Convention | Meaning | Examples |
|---------------------------|---|---|
| Hot keys | When hot keys are shown, a plus (+) appears between two keys that must be pressed at the same time, and a space appears between two keys that must be pressed sequentially. | <code>Ctrl+k p</code> entered while the user is connected to a KVM port brings up an IPDU power management screen. <code>Ctrl</code> and <code>k</code> must be pressed at the same time followed by <code>p</code> . |
| Navigation shortcuts | Shortcuts use the “greater than” symbol (>) to indicate how to navigate to Web Manager forms or OSD screens. | Go to Configuration>KVM>General >IP Users in Expert mode. |

Additional Resources

The following sections describe technical support, training, and software upgrades.

Cyclades Technical Support

Cyclades offers free technical support. To find out how to contact the support center in your region, go to: http://www.cyclades.com/support/technical_support.php.

Cyclades Technical Training

To learn more about Cyclades Technical Training Center and courses offered, visit <http://www.cyclades.com/training>, call 1-888-292-5233, or send an email to training@cyclades.com.

Cyclades Software Upgrades

Cyclades offers periodic software upgrades for the AlterPath products free of charge to current Cyclades customers. You may want to check http://www.cyclades.com/support/downloads.php#alterpath_pm from time to time to see if upgrades are available for the AlterPath PM.

See “Upgrading the AlterPath PM Firmware” on page 43 for instructions on upgrading the software on your AlterPath PM.

Chapter 1

Introduction

The AlterPath PM is an intelligent power distribution unit (IPDU) that enables remote power control of servers and network gear. When used in conjunction with Cyclades console servers or KVM devices, the AlterPath PM delivers easier management capabilities and faster problem solving by integrating console/KVM access and power control into one single interface.

The following sections describe general features common to all PM models in addition to pointing out specific features of certain units.

Description

The following sections describe common features among all AlterPath PM units.

Alarms and Monitoring

The AlterPath PM delivers accurate, real-time global current monitoring of all connected devices via the user interface screen or locally through an LED digital display. Users have the ability to set a current alarm threshold that, once exceeded, will cause the AlterPath PM to sound an alarm or send a notification message, or both. The LED current display also blinks when the alarm threshold is exceeded.

Sequential Power Up

The AlterPath PM incorporates a sequential power up feature that prevents all power outlet receptacles from turning on at once, eliminating the potential of current surges that could render the equipment inoperable. Together with the global current monitoring, the sequential power-up feature lets users safely install more equipment on existing power circuits without the worry of current overloads.

Support for Daisy Chaining

The IPDU has a fixed number of power-outlet receptacles, but with daisy chaining capabilities, users can increase capacity by connecting the control interfaces of several AlterPath PMs in a series.

Creation of User Accounts

The AlterPath PM allows one administrator and up to eight users (not simultaneously) to connect to it through its RS-232 serial port. After a successful authentication, it performs the following functions:

- Reads and displays the total current being used by the entire AlterPath PM.
- Manages power outlets (by powering them on and off, locking and unlocking them, and/or power cycling them).
- Manages users.
- Monitors power variables.
- Can be used as a stand-alone IPDU (independent of any other hardware) and controlled by any simple terminal access program like Minicom on Linux or HyperTerminal on Microsoft operating systems.

Integration with Cyclades Management Products

When used with the ACS/TS family, the OnSite, or the KVM family, the AlterPath PM offers a superior feature set that is not fully covered in this manual. Please refer to the appropriate Cyclades documentation for more information on how to use the AlterPath PM with your specific implementation.

Hardware Configuration Options

The AlterPath PM can be used in one of three hardware configurations:

- Standalone – Managed independently of any other hardware device.
See “Standalone Configuration” on page 4.
- Daisy-chained – Multiple slave PMs connected to one another and managed by one master PM.
See “Daisy-chained Configuration” on page 5.
- Integrated – Managed by a Cyclades TS, AlterPath ACS, AlterPath OnSite, one of the AlterPath KVM products, or by any other console/terminal management device.

See “Integrated Configuration” on page 6.

Standalone Configuration

In a standalone configuration, the AlterPath PM operates independently of any other hardware such as the TS or ACS. The following graphic displays a PM with the console port connected to a computer running HyperTerminal, Kermit, or Minicom.

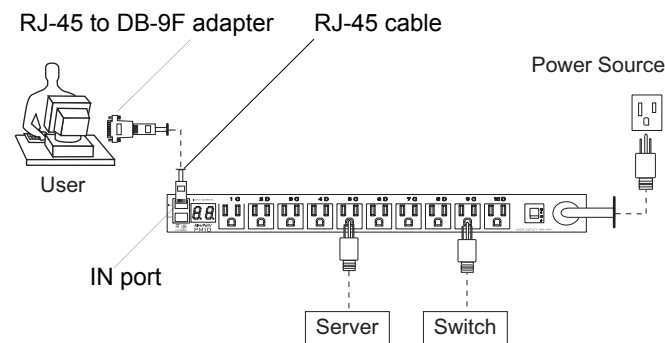

Figure 1-1: Standalone Configuration

Note: The previous graphic displays the PM being connected to the local work station with the RJ-45 to DB-9F adapter that is shipped with the product. If your work station does not have a DB-9M COM port, you may need to use a USB serial adapter in order to connect to the computer’s USB port.

For specific installation instructions, see “Setting Up the AlterPath PM” on page 26.

Daisy-chained Configuration

In a daisy-chained configuration, multiple slave PMs are connected to one another and managed by a single master PM. The PMs are linked together with RJ-45 cables connected to one PMs OUT port and the other PM’s IN port. This example shows four AlterPath PMs operating in a daisy-chained environment. PM #1 is connected to the local work station and is the “master” PM, while the other three PMs are “slaves.”

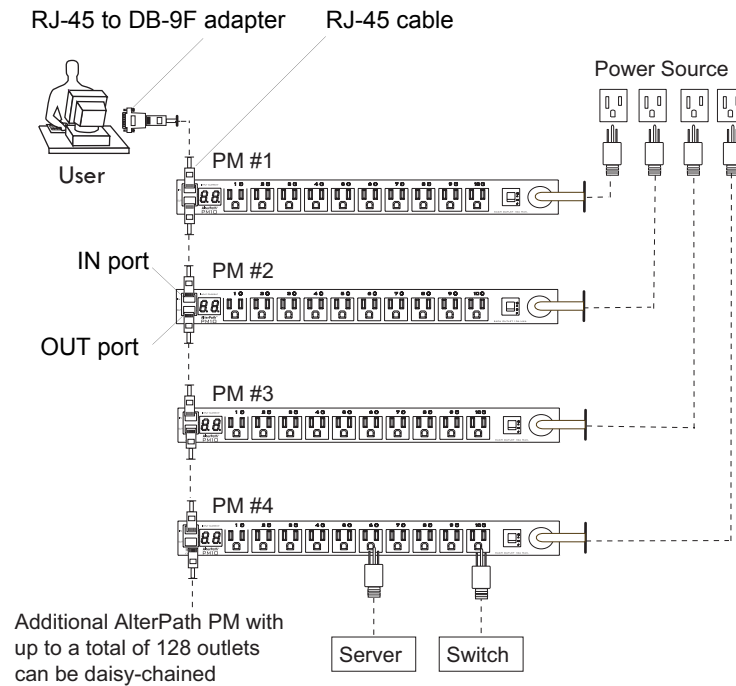

Figure 1-2: Daisy-chained Configuration

Note: The previous graphic displays the PM being connected to the local work station with the RJ-45 to DB-9F adapter that is shipped with the product. If your work station does not have a DB-9M COM port, you may need to use a USB serial adapter in order to connect to the computer's USB port.

The PMs in the previous graphic are configured to be used independently of any other hardware such as the AlterPath ACS or Cyclades-TS.

Integrated Configuration

In an integrated configuration, the AlterPath PM is configured to work in conjunction with one of the following Cyclades management products:

- Cyclades-TS
- AlterPath ACS
- AlterPath OnSite
- AlterPath KVM family.

A user connects to the AlterPath PM by accessing the appropriate console port of the Cyclades management product. In this scenario, software configuration on and monitoring of the AlterPath PM is done through the Cyclades management product and not on the PM itself. The setup and configuration instructions for the Cyclades management products can be found in the appropriate documentation available at <http://www.cyclades.com/support/downloads.php>.

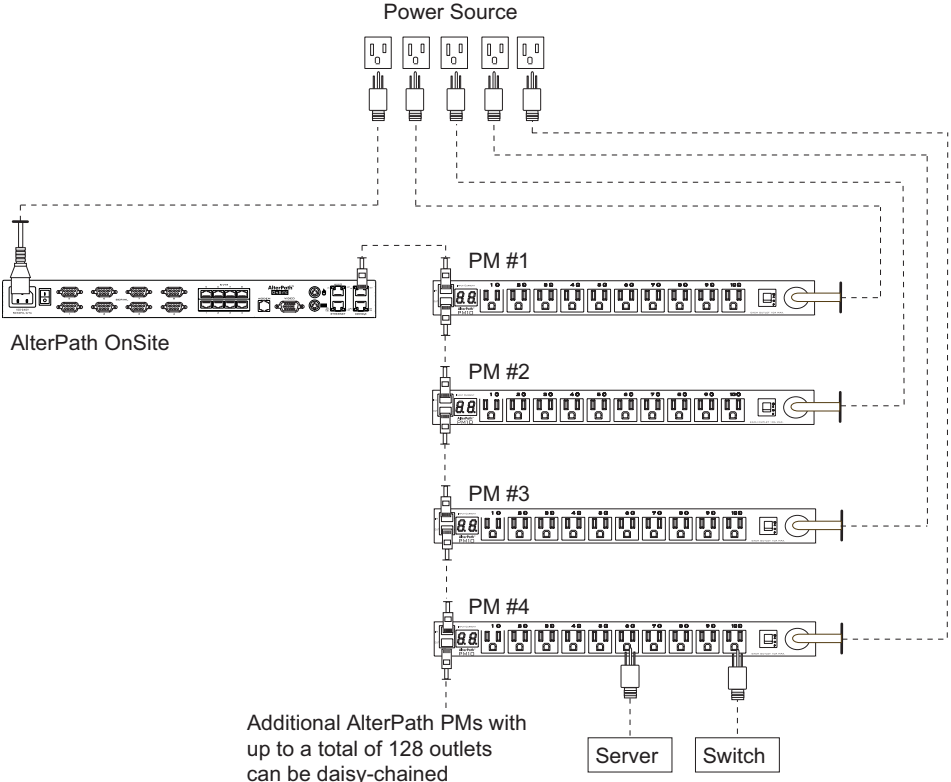

Figure 1-3: The AlterPath PM with a Cyclades Management Device

An integrated environment offers the following advantages:

- IT professionals can power off, power on, and reboot network devices using the same console management session from any location via telnet, Secure Shell (SSHv2), or through a secure web session. This can all be done without the need for physical access to the hardware.
- Ethernet connection is available through the Cyclades management products to which the AlterPath PM is connected. When used with Cyclades management product, the AlterPath PM allows you, via a configurable hotkey, to reboot servers without leaving your telnet/ssh session.
- The AlterPath PM inherits the security of the console server to which it is connected.

Daisy chaining PMs with the AlterPath ACS or Cyclades-TS is similar to the daisy-chained configuration as described in “Daisy-chained Configuration” on page 5; however, in the integrated configuration, the first AlterPath PM is connected to a Cyclades management device instead of a workstation.

Accessing the System Console

Users and administrators can access the AlterPath PM either by making a direct console connection to the PM’s IN port or by connecting the PM to a Cyclades console or KVM management device.

Direct Console Access

While using the PM device independently of other Cyclades devices, local users can connect directly to the system console port (the “IN” port) of the AlterPath PM using the console cable with the corresponding adapter(s).

For more information about connecting directly to the PM’s console, see “Making a Direct Connection for Console Access” on page 33.

Console Access through a Management Device

While integrating the PM device with a Cyclades console or KVM management device such as the AlterPath ACS or the AlterPath OnSite, remote users can access the AlterPath PM's console port through one of the following interfaces:

- Menu-driven interface – After using telnet or SSH to access the console port equivalent to the managed device on the console server, type the power management hotkey (Ctrl+p by default) to bring up a power management menu on the same screen.
- Web interface – Once you are logged into the Web Interface of the management device, access the power management functionality from a “Power Management” or “IPDU Power Management” tab on the Web Manager.

See “Integration with Cyclades Management Products” on page 3 for more background information on integrating a PM with a Cyclades management device, or refer to the appropriate user documentation for instructions on accessing the PM console through your specific Cyclades management device.

Models and Components

General features, which are common among all products, in the AlterPath PM family are listed below:

- 128 KB flash memory
- 8 KB RAM
- Two RJ-45 RS-232 interfaces
- Digital global current display with 2 digits and 7 segments
- LEDs monitoring ON/OFF status for each port
- Audible over current alarm
- 8-bit Microcontroller-equipped

Models and Components

The following sections list features that are specific to each model:

- “AlterPath PM8” on page 10
- “AlterPath PM8i” on page 11
- “AlterPath PM10” on page 12
- “AlterPath PM10i” on page 13
- “AlterPath PM10i-L30A” on page 14
- “AlterPath PM10i-32A” on page 14
- “AlterPath PM10i-32Au” on page 15
- “AlterPath PM20” on page 15
- “AlterPath PM20i” on page 16

If needed, see Appendix A: “Specifications” for more electrical, hardware, and environment details about each model. See “Reviewing the Shipping Box Contents” on page 20 for pictures of the components available with each PM model.

AlterPath PM8

The AlterPath PM8 has the following features:

- One of the following power plugs:
 - 125VAC/15A (NEMA 5-15P)
 - 125VAC/20A (NEMA 5-20P)
 - 125VAC/20A (NEMA L5-20P)
- Eight 125VAC/15A power receptacles (NEMA 5-15R)
- 125VAC/20A circuit breaker
- Vertical mounting (zero U)

The following graphic depicts the AlterPath PM8.

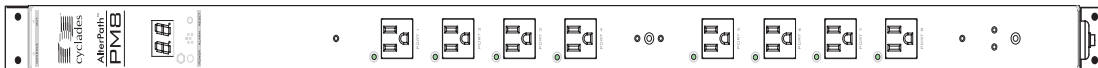

Figure 1-4: AlterPath PM8

AlterPath PM8i

The AlterPath PM8i has the following features:

- One 240VAC/8A power plug (IEC320-C14)
See “AlterPath PM8i-15A and AlterPath PM10i-10A Power Cables” on page 23 for a list of which power cables are supplied by region.
- Eight 240VAC/8A power receptacles (IEC320-C14)
- 240VAC/10A supplementary protector
- Vertical (zero U) & Horizontal (1.5 U) mounting

The following graphic depicts the AlterPath PM8i.

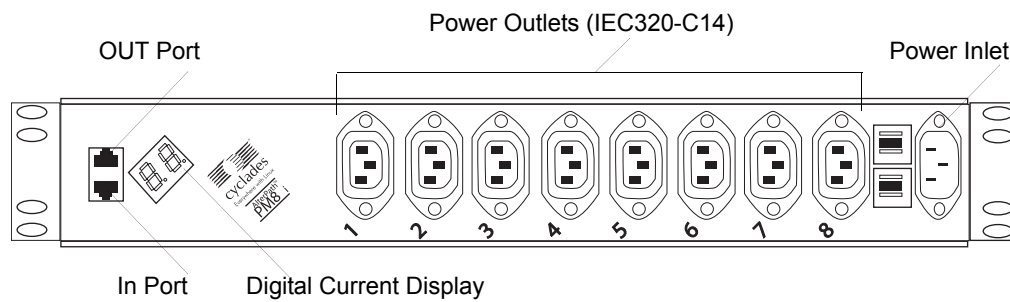

Figure 1-5: AlterPath PM8i

AlterPath PM10

The AlterPath PM10 has the following features:

- One of the following power plugs:
 - 125VAC/15A power plug (NEMA 5-15P)
 - 125VAC/20A power plug (NEMA 5-20P)
 - 125VAC/20A power plug (NEMA L5-20P)
 - 125VAC/30A power plug (NEMA L5-30P)
- Ten 125VAC/15A power receptacles (NEMA 5-15R)
- 125VAC/15A/20A/two 15A circuit breakers
- Horizontal mounting (1U)

The following graphic depicts the AlterPath PM10.

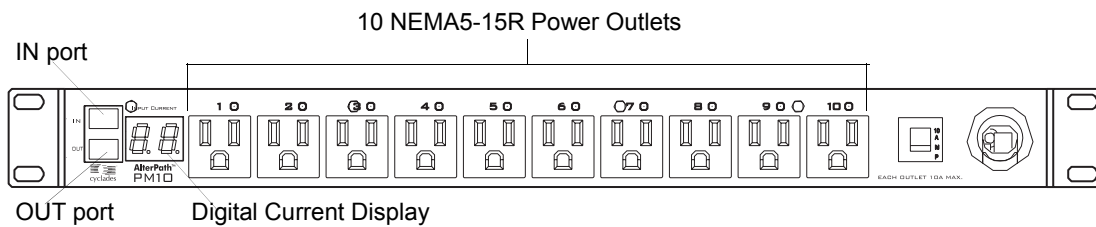

Figure 1-6: AlterPath PM10

AlterPath PM10i

The AlterPath PM10i has the following features:

- One of the following power plugs:
 - 240VAC/10A power plug (IEC320-C14)
 - 240VAC/16A power plug (IEC320-C20)
- Ten 240VAC/10A power receptacles (IEC320-C13)
- 240VAC/10A/20A supplementary protector
- Horizontal (1U) mounting

The following graphic depicts the back of the AlterPath PM10i.

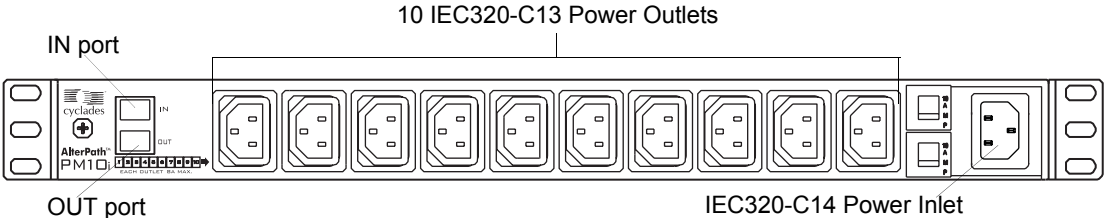

Figure 1-7: AlterPath PM10i Back

The following graphic depicts the back of the AlterPath PM10i.

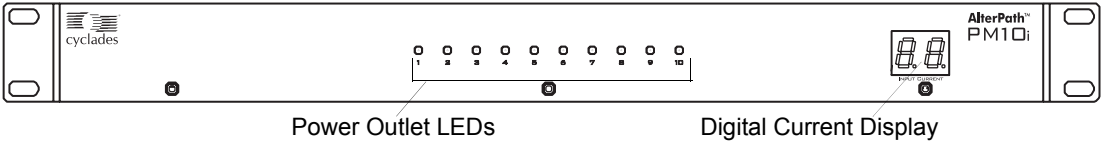

Figure 1-8: AlterPath PM10i Front

AlterPath PM10i-L30A

The AlterPath PM10i L30A has the following features:

- 30A input power cord. L6-30P plug (USA model)
- Ten 240VAC/10A power receptacles (IEC320-C13)
- Two 240VAC/15A magnetic circuit breakers with “press to reset” function
- Horizontal (1U) mounting

Refer to Figure 1-7: AlterPath PM10i Back on page 13 and Figure 1-8: AlterPath PM10i Front on page 13 for images of the AlterPath PM10i L30A.

AlterPath PM10i-32A

The AlterPath PM10i-32A has the following features:

- 32A input power cord; IEC 309 plug.
- Ten 240VAC/10A power receptacles (IEC320-C13)
- Two 240VAC/16A magnetic circuit breakers with accidental-off protection function
- Horizontal (1U) mounting

Refer to Figure 1-7: AlterPath PM10i Back on page 13 and Figure 1-8: AlterPath PM10i Front on page 13 for images of the AlterPath PM10i-32A.

AlterPath PM10i-32Au

The AlterPath PM10i-32Au has the following features:

- 32A unterminated input power cord
- Ten 240VAC/10A power receptacles (IEC320-C13)
- Two 240VAC/16A magnetic circuit breakers with accidental-off protection function
- Horizontal (1U) mounting

Refer to Figure 1-7: AlterPath PM10i Back on page 13 and Figure 1-8: AlterPath PM10i Front on page 13 for images of the AlterPath PM10i-32Au.

AlterPath PM20

The AlterPath PM20 is available in three models: PM20-15A, PM20-20A, and PM20-30A. Each model has the following features:

- One of the following power plugs:
 - 125VAC/15A power plug (NEMA 5-15P)
 - 125VAC/20A power plug (NEMA 5-20P)
 - 125VAC/20A power plug (NEMA L5-20P)
 - 125VAC/30A power plug (NEMA L5-30P)
- 20 125VAC/15A power receptacles (NEMA 5-15R)
- 125VAC/20A circuit breaker (15A, 20A, and 30A models)
- Vertical mounting (zero U)

The following graphic depicts the AlterPath PM20.



Figure 1-9: The AlterPath PM20

AlterPath PM20i

The AlterPath PM20i has the following features:

- One of the following power plugs:
 - 240VAC/16A power plug (IEC320-C20)
 - 240VAC/20A power plug (IEC320-C20)
- Twenty 240VAC/10A power receptacles (IEC320-C13)
- 240VAC/20A supplementary protector with a “press to reset” function on the L30A models
- 240VAC/15A branch circuit breaker with accidental-off protected feature (30A model)
- Vertically (0U) mounting

The following graphic depicts the AlterPath PM20i.



Figure 1-10:The AlterPath PM20i

AlterPath PM20i 32A

The AlterPath PM20i 32A has the following features:

- 32A input power cord; IEC 309 plug.
- Twenty 240VAC/10A power receptacles (IEC320-C13)
- 240VAC/two 16A magnetic circuit breakers with accidental-off protection function
- Horizontal (1U) mounting

Refer to Figure 1-10: The AlterPath PM20i on page 16 for an image of the AlterPath PM20i-32A.

AlterPath PM20i 32Au

The AlterPath PM20i 32Au has the following features:

- 32A unterminated input power cord
- Twenty 240VAC/10A power receptacles (IEC320-C13)
- 240VAC/two 16A magnetic circuit breakers with accidental-off protection function
- Horizontal (1U) mounting

Refer to Figure 1-10: The AlterPath PM20i on page 16 for an image of the AlterPath PM20i-32Au.

Models and Components

Chapter 2

Installation

The following sections outline and describe tasks for installing the AlterPath PM and provide other important installation-related information.

The following table lists the basic installation tasks in the order in which they should be performed and shows the page numbers where the tasks are described in more detail.

| | | |
|----------|--|---------|
| 1 | Gathering Required Equipment | Page 20 |
| 2 | Reviewing the Shipping Box Contents | Page 20 |
| 3 | Setting Up the AlterPath PM | Page 26 |
| 4 | (Optional) Daisy Chaining PMs | Page 31 |
| 5 | Plugging Devices Into AlterPath PM Outlets | Page 32 |
| 6 | Powering On the AlterPath PM | Page 32 |
| 7 | Making a Direct Connection for Console Access | Page 33 |
| 8 | Finishing configuration and managing the connected devices | Page 37 |

Gathering Required Equipment

Collect the following equipment prior to installing and configuring the AlterPath PM in standalone configuration:

- One or more RJ-45 to RJ-45 straight-through cables.
- An RJ-45 to DB-9F straight-through adapter.
- A PC running a terminal emulation program.

See the following section “Reviewing the Shipping Box Contents” on page 20 for the list of other necessary items that come with the AlterPath PM.

Reviewing the Shipping Box Contents

All AlterPath PM models are shipped with the PM itself along with the items shown in Table 2-1. The entry for each part provides an illustration, its part number (P/N), description, and purpose. You can use check boxes to check off each item, and you can use the part numbers from this table to reorder any of the parts.

Table 2-1: PM Shipping Box Contents, Part Numbers, and Description

| <input checked="" type="checkbox"/> | Item | P/N | Description | Purpose |
|-------------------------------------|---|---------|---------------------------------------|--|
| <input type="checkbox"/> |  | PAC0226 | Documentation CD | PDF copies of this guide and all other Cyclades product documents. |
| <input type="checkbox"/> |  | PAC0225 | <i>AlterPath PM Quick Start Guide</i> | Basic installation guide for experienced users in printed format. |

Table 2-1: PM Shipping Box Contents, Part Numbers, and Description (Continued)



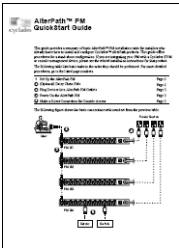

| <input checked="" type="checkbox"/> | Item | P/N | Description | Purpose |
|-------------------------------------|---|---------|---|---|
| <input type="checkbox"/> |  | CAB0018 | RJ-45 to RJ-45 7ft. CAT5 cable | <p>Used for the following:</p> <ul style="list-style-type: none"> • Along with an adapter, to connect a terminal or PC to the IN port. See “To Access the Console” on page 34. • To connect to a Cyclades console or KVM management device. • To connect to another AlterPath PM in a daisy chain. See “To Daisy Chain a PM” on page 31. |
| <input type="checkbox"/> |  | ADB0036 | RJ-45 to DB-9F straight-through adapter | <p>Along with an RJ-45 cable, used to connect a terminal or PC to a PC’s COM port. See “To Access the Console” on page 34.</p> |
| <input type="checkbox"/> |  | CON0132 | RJ-45 loopback connector | <p>In the case that the administrator forgets the admin's password, this is used to place in the OUT port to gain temporary access to the box using the factory default password.</p> <p>See “To Reset the Admin Password Using the Loopback Connector” on page 41.</p> |

Table 2-1: PM Shipping Box Contents, Part Numbers, and Description (Continued)

| <input checked="" type="checkbox"/> | Item | P/N | Description | Purpose |
|-------------------------------------|---|---------|--|--|
| <input type="checkbox"/> |  | HAR0220 | 2 mounting brackets with 8 screws (2 spares) | Use to mount the AlterPath PM to a rack or wall. See “To Mount the AlterPath PM8i, PM10, or PM10i” on page 29. |

See the following sections for a list of additional items shipped with specific AlterPath PM models.

Modular Input Power Cables for the AlterPath PM

If your PM model does not have a fixed power input cable, it may ship with one of the modular cables listed in the following sections. Depending on your site’s location, the modular input power cables included in the box vary. See the following sections to find the input cable that should ship with your PM product:





- “AlterPath PM8i-15A and AlterPath PM10i-10A Power Cables” on page 23
- “AlterPath PM10i-15A Power Cables” on page 24
- “AlterPath PM10i-16A and AlterPath PM 20i-16A Power Cables” on page 24

Note: The AlterPath PM 10i-32Au ships with an unterminated power cord. If necessary, your Cyclades representative can provide guidelines on approved power plug installation.

AlterPath PM8i-15A and AlterPath PM10i-10A Power Cables

The following table lists the power cables available for the AlterPath PM 8i-15A and AlterPath PM10i-10A by region.

Table 2-2: AlterPath PM8i-15A and AlterPath PM10i-10A Cables

| <input checked="" type="checkbox"/> | Cable | P/N | Country/Region |
|-------------------------------------|---|---------|----------------------------|
| <input type="checkbox"/> |  | CAB0089 | US |
| <input type="checkbox"/> |  | CAB0055 | Australia and New Zealand |
| <input type="checkbox"/> |  | CAB0087 | Continental Europe |
| <input type="checkbox"/> |  | CAB0088 | United Kingdom and Ireland |

AlterPath PM10i-15A Power Cables

The following table lists the power cables available for the AlterPath PM10i-15A.

Table 2-3: AlterPath PM10i-15A

| <input checked="" type="checkbox"/> | Cable | P/N | Country/Region |
|-------------------------------------|---|---------|----------------|
| <input type="checkbox"/> |  | CAB0191 | US |

AlterPath PM10i-16A and AlterPath PM 20i-16A Power Cables

The following table lists the power cables available for the AlterPath PM10i-16A and AlterPath PM 20i-16A.

Table 2-4: AlterPath PM10i-16A and AlterPath PM 20i-16A



| <input checked="" type="checkbox"/> | Cable | P/N | Country/Region |
|-------------------------------------|---|---------|---------------------------|
| <input type="checkbox"/> |  | CAB193 | Continental Europe |
| <input type="checkbox"/> |  | CAB0192 | Australia and New Zealand |

Table 2-4: AlterPath PM10i-16A and AlterPath PM 20i-16A

| <input checked="" type="checkbox"/> | Cable | P/N | Country/Region |
|-------------------------------------|---|---------|----------------------------|
| <input type="checkbox"/> |  | CAB0194 | United Kingdom and Ireland |

AlterPath PM10i-20A and AlterPath PM 20i-20A Power Cables

The following table lists the power cables available for the AlterPath PM10i-20A and AlterPath PM 20i-20A.

Table 2-5: AlterPath PM10i-20A and AlterPath PM 20i-20A



| <input checked="" type="checkbox"/> | Cable | P/N | Type |
|-------------------------------------|---|---------|-------------------|
| <input type="checkbox"/> |  | CAB197 | US NEMA L6-20P |
| <input type="checkbox"/> |  | CAB0195 | US NEMA 5-20P |

Table 2-5: AlterPath PM10i-20A and AlterPath PM 20i-20A

| <input checked="" type="checkbox"/> | Cable | P/N | Type |
|-------------------------------------|---|---------|-------------------|
| <input type="checkbox"/> |  | CAB0198 | US NEMA L5-20P |

Optional Outlet Cable Package

The following cable packages can be ordered separately for the IEC PM models:

- 8-outlet cables (C13 male to C14 female) (ACS0040).
- 10-outlet cables (C13 male to C14 female) (ACS00046).

Setting Up the AlterPath PM

You can mount the AlterPath PM on a rack or wall or place it on a desktop or other flat surface. Two brackets are supplied with six Phillips screws for attaching the brackets to the AlterPath PM for mounting.

- If you are not mounting the AlterPath PM, place the AlterPath PM on a desk or table.
- If you are mounting the AlterPath PM, obtain a Phillips screwdriver and appropriate nuts and bolts before starting the following procedure.

Note: When mounting an AlterPath PM 0U model to a wall stud, securely mount it by using a #10 or larger screw or use a drywall fastener rated min. 25 lb (11.34 kg).

The following graphics depict the orientation of the brackets for front rack mounting AlterPath PM.

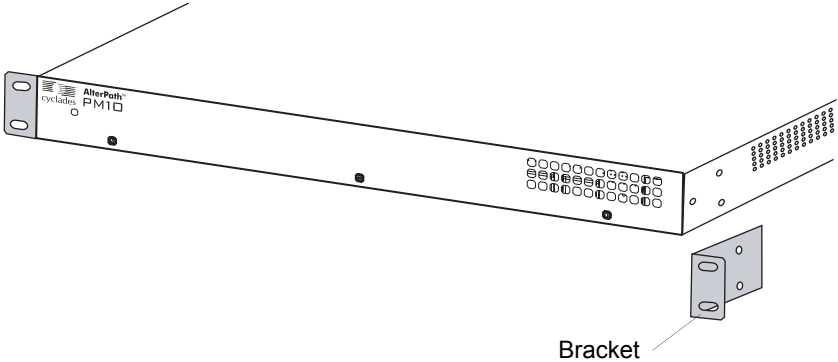

Installation Environment

When installing AlterPath PM, ensure that the following environment specifications are met.

Table 2-6: AlterPath PM Optimum Installation Environment

| Environment Factor | Recommendation |
|---|---|
| Temperature | The manufacturer's maximum recommended ambient temperature for the AlterPath PM is 122 °F (50 °C). |
| Elevated Operating Ambient Temperature | If the AlterPath PM is installed in a closed or multi-unit rack assembly, the operating ambient temperature of the rack environment may be greater than room ambient temperature. Therefore, consideration should be given to installing the equipment in an environment compatible with the manufacturer's maximum rated ambient temperature. See above. |
| Reduced Air Flow | Installation of the equipment in a rack should be such that the amount of air flow required for safe operation of the equipment is not compromised. |

Table 2-6: AlterPath PM Optimum Installation Environment

| Environment Factor | Recommendation |
|----------------------------|--|
| Mechanical Loading | Mounting of the equipment in the rack should be such that a hazardous condition is not achieved due to uneven mechanical loading. |
| Circuit Overloading | Consideration should be given to the connection of the equipment to the supply circuit and the effect that overloading of circuits might have on overcurrent protection and supply wiring. Appropriate consideration of equipment nameplate ratings should be used when addressing this concern. |
| Reliable Grounding | Reliable grounding of rack-mounted equipment should be maintained. Particular attention should be given to supply connections other than direct connections to the branch circuit, such as power strips or extension cords. |

Important: Install the AlterPath PM 0U model in a location where there is an adjacent and accessible wall socket outlet.

▼ **To Mount the AlterPath PM8i, PM10, or PM10i**

- 1. Locate the appropriate sets of holes on the PM.

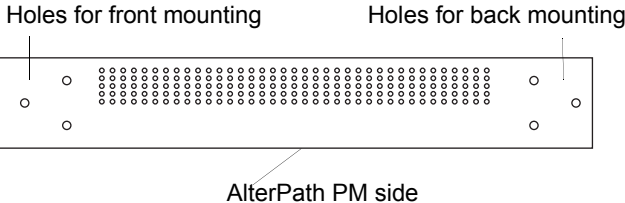
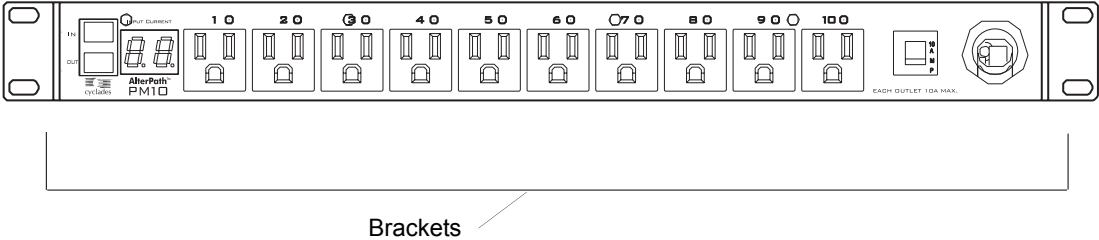

Figure 2-11: Rack Mounting Holes on the AlterPath PM

- 2. Connect the two supplied brackets to the AlterPath PM, connecting one bracket to each side of the box.
- 3. For each bracket, insert a screw through each of the three holes on the bracket into the appropriate holes at either end of the AlterPath PM.

The following figure shows the bracket flanges on the front of the AlterPath PM after the brackets are installed.



- 4. Use a Phillips screwdriver to tighten the screws.
- 5. Use the mounting hardware recommended for your rack to mount the AlterPath PM on a rack as illustrated in the following graphic.

Note: The suggested minimum screw size for wall-mounting the AlterPath PM units is #10 (4.8 mm or 0.19 in or 3/16 in) or larger. The RJ-45 cable included in the AlterPath PM package is minimum flame rated VW-1 or FT-1 and has a maximum length of 10 feet (3 meters).

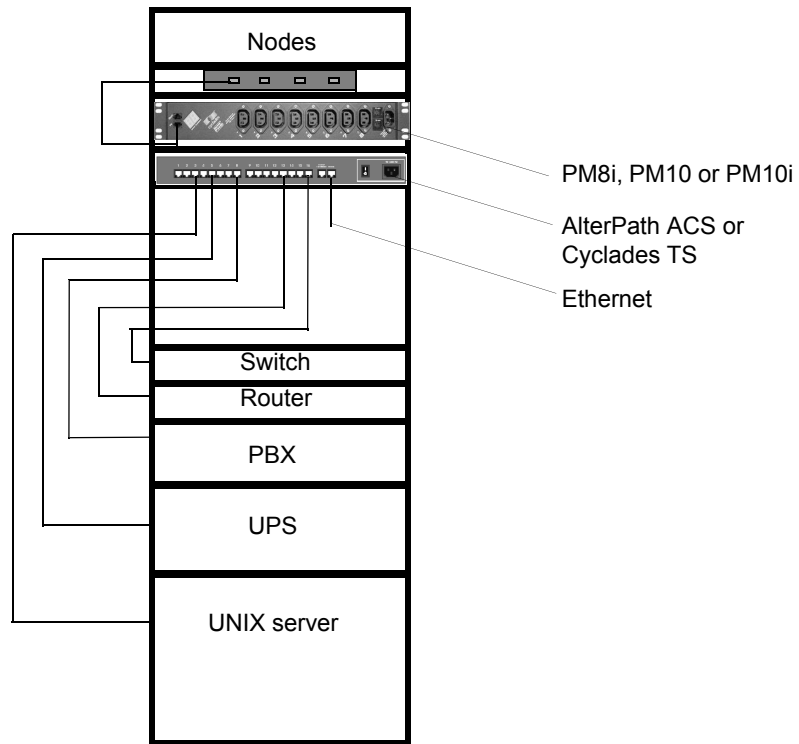

Figure 2-12: Rack Mount for the AlterPath PM8i

Daisy Chaining PMs

You can manage a maximum of 128 outlets from a single work station by connecting slave PMs to the master PM device. See “Making a Direct Connection for Console Access” on page 33 for more details.

▼ *To Daisy Chain a PM*

This procedure assumes that a master PM is already connected to a work station or to a Cyclades console or KVM device.

1. Connect one end of an RJ-45 cable to the OUT port of the main AlterPath PM, which is connected to a work station or to a Cyclades console or KVM device (master).
2. Connect the other end of the RJ-45 cable to the IN port of the secondary AlterPath PM (slave).
3. To connect another PM to the slave, connect one end of an RJ-45 cable to the OUT port of the last PM in the chain.
4. Repeat Step 3 until you have connected the desired number of PMs.

You can control up to 128 power outlets in any combination of PM models.

Plugging Devices Into AlterPath PM Outlets

In order to control power on a device, the device must be plugged into at least one of the AlterPath PM's power outlets.

▼ *To Plug Devices Into AlterPath PM Outlets*

1. Connect a device's power cable to one of the AlterPath PM's outlets.
2. Repeat step one until all of the AlterPath PM's power outlets are used.

Powering On the AlterPath PM

Power on the AlterPath PM in order to begin managing power of its connected devices.

▼ *To Power On the AlterPath PM*

- Plug the power cable into an adjacent AC power source.

Important: The AlterPath PM must be powered by a receptacle with adequate circuit protection.

Making a Direct Connection for Console Access

The system administrator must specify basic settings on the AlterPath PM before users can connect to and manage the unit and the connected devices. To prepare to perform necessary basic configuration, make a direct connection to the AlterPath PM by connecting a terminal or computer to the IN port as depicted in the following graphic.

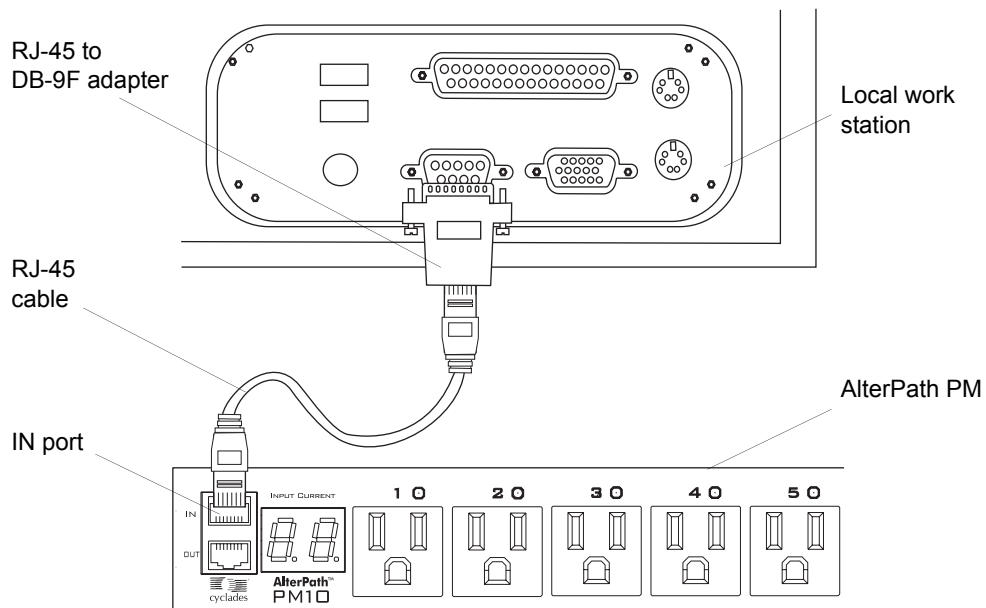

Figure 2-13:Connecting a Local Work Station to the AlterPath PM

▼ **To Access the Console**

Perform the following steps to connect a computer to the console port of the AlterPath PM. This procedure assumes that you know how to use a terminal emulation program.

On a PC, ensure that HyperTerminal or another terminal emulation program is installed on the Windows operating system. On a computer running a UNIX-based operating system, such as Solaris or Linux, make sure that a compatible terminal emulator, such as Kermit or Minicom, is installed.

1. Connect an RJ-45 serial cable to the IN port on the AlterPath PM.
2. Connect the other end of the RJ-45 serial cable to an RJ-45 to DB-9F adapter shipped with the PM.
3. Connect the adapter to a DB-9 serial port on a computer.

You may need to use a USB serial adapter in order to connect to the computer.

4. Using a terminal emulation program installed on a computer, start a session with the following console port settings:

| | |
|-------------------------------|---------------------------|
| Serial Speed: 9600 bps | Stop Bits: 1 |
| Data Length: 8 bits | Flow Control: None |
| Parity: None | ANSI emulation |

▼ **To Log Into the AlterPath PM Through the Console (In Port)**

1. From your terminal emulation application, log into the console port as “admin”.

```
AlterPath PM
Copyright (c) 2002-2005
Cyclades Corporation
V 1.7.1 Oct 4, 2005
[PM]: IPDU: 1
[PM]: OUT: 8
Username:
```

As shown in the previous screen, the default password is “pm8.” If the password has been changed from the default, use the new password.

2. If this is a first-time installation, see “Initial Configuration Using the Command Prompt” on page 38 for instructions on changing the default password, adding users, and assigning outlets to users.
3. See “Command Line Interface” on page 49, for procedures on logging in and using the console commands to manage power on connected devices.

Making a Direct Connection for Console Access

Chapter 3

Configuration

The AlterPath PM can be configured by any one of three methods:

- Command Prompt
- Browser – Available only when used in an integrated configuration.
- Text-based menu – Available only when used in an integrated configuration, this menu allows you to invoke the various PM operations such as cycling, switching on/off, and more.

The following sections offer basic instructions for configuring, restoring the admin password, and uploading firmware on the AlterPath PM for either the standalone or the daisy-chained configuration.

For information about integrated use with the AlterPath ACS, Cyclades-TS, AlterPath KVM family of products, or the AlterPath Onsite, refer to the *AlterPath ACS User Guide*, the *Cyclades-TS User Guide*, the *AlterPath KVM/net Plus Installation, Configuration, and User's Guide*, or the *AlterPath OnSite Installation, Administration, and User's Guide* respectively.

Default Configuration Parameters

The AlterPath PM's default configuration is as follows:

- User is *admin*.
- admin user's password is *pm8*.
- All outlets are *un-named*.
- All outlets are *unassigned to user*.
- All outlets are *turned on*.
- All outlets are *unlocked*.

Initial Configuration Using the Command Prompt

To configure the AlterPath PM, you must have a work station connected to the console (In) port on the AlterPath PM and be logged in as the admin user. See "Making a Direct Connection for Console Access" on page 33 for instructions on connecting to the console. If needed, refer to Chapter 4. "Command Line Interface" on page 49 for a description of the command line interface and reference information on each of the commands described in the following procedures.

Use the following procedures to perform basic configuration:

| | |
|---|---------|
| To Change the Default Password | Page 39 |
| To Create Users Using the adduser Command | Page 39 |
| To Assign Outlets to Users Using the assign Command | Page 40 |
| To Name the Outlets Using the name Command | Page 40 |
| To Save the Configuration Using the save Command | Page 40 |

▼ **To Change the Default Password**

If the default password “pm8” is still in use, change the admin password.

Important: Changing the default password closes a security hole that could be easily exploited.

1. Login to the AlterPath PM.

Use the factory default username/password *admin/pm8*. A maximum of eight characters (not case sensitive) is allowed.

2. Enter the **passwd** command.

```
pm> passwd
```

3. Enter a new password when prompted.

```
Password: <new password>
Re-enter password: <new password>
Username/password set for user admin.
pm>
```

▼ **To Create Users Using the adduser Command**

1. Login to the AlterPath PM.

The PM prompt appears

```
pm>
```

2. Enter the **adduser** command followed by the new username and enter the password when prompted.

```
pm> adduser jane
Password:
Re-enter password:
Username/password set for user jane.
```

▼ **To Assign Outlets to Users Using the assign Command**

1. Login to the AlterPath PM.

The PM prompt appears.

```
pm>
```

2. Enter the `assign` command followed by the outlets and username.

```
pm>assign 2 jane
Outlet 2 assigned to jane.
```

▼ **To Name the Outlets Using the name Command**

1. Login to the AlterPath PM.

The PM prompt appears.

```
pm>
```

2. Enter the `name` command followed by the outlet number and desired name of the outlet.

```
pm>name 2 chispa
2: Outlet now named chispa
```

▼ **To Save the Configuration Using the save Command**

1. Login to the AlterPath PM.

The PM prompt appears.

```
pm>
```

2. Enter the `save` command to save the configuration.

```
pm>save
Saving configuration to flash on IPDU #1 ... Done.
Saving configuration to flash on IPDU #2 ... Done.
```

Resetting the Admin Password

In the event the administrator wants to reset the password for the AlterPath PM (for example, if the administrator forgets the admin password), then the loopback connector that is shipped with the AlterPath PM can be used for temporary access to the PM.

▼ **To Reset the Admin Password Using the Loopback Connector**

1. Do one of the following procedures:
 - a. If you are currently logged into the AlterPath PM as a regular user, log out by typing `exit`.
 - b. If you are already logged into the AlterPath PM as an administrator, proceed to Step 2.

2. Attach the loopback connector.

Connect the loopback connector shipped with the product to the OUT port of the AlterPath PM. If necessary, disconnect any cables connected to the OUT port of the AlterPath PM to allow for the connection of the loopback.

3. Wait one minute and then check the display.

Resetting the Admin Password

If you are watching the AlterPath PM's console output (using HyperTerminal or Minicom), messages like the ones shown below are displayed:

```
[ALTERPATH PM]: DCD went ON on output port of IPDU #1
[ALTERPATH PM]: Trying to detect loopback cable on
OUT port of ipdu #1
[ALTERPATH PM]: Loopback detected. Changing
administrator password to default.
[ALTERPATH PM]: Please remove the loopback cable now.
```

4. Remove the loopback connector.

After one minute, you can remove the loopback connector from the OUT port of the AlterPath PM. Now the password for the user *admin* is reset to the default (*pm8*), and you should be able to log into the AlterPath PM using the default username/password.

5. Change the password for the *admin*, if desired, by issuing the following command:

```
pm>passwd
```

6. Execute the `save` command to complete the procedure.

7. If you need to recover the password of many AlterPath PMs connected in a daisy chain, go to Step 1 and perform the procedure on each AlterPath PM in the chain.

Upgrading the AlterPath PM Firmware

Starting with version 1.1.0, the AlterPath PM firmware can be upgraded through its “In” port.

The upgrade procedure described here is only valid for units that are currently running firmware versions 1.3.0 or greater. If your AlterPath PM unit is running an older firmware version, please follow the instructions in the manual that corresponds to the firmware currently installed on the AlterPath PM. Older versions of this manual can be found at:

<ftp://ftp.cyclades.com/pub/cyclades/alterpath/pm/doc/>

▼ To Upgrade PM Firmware

1. Download the new AlterPath PM firmware from the Cyclades website.

The latest AlterPath PM firmware is available in the download section of the Cyclades website, at <http://www.cyclades.com/support/downloads.php>

After downloading the AlterPath PM firmware file, save it to the workstation connected to the AlterPath PM console (IN port).

2. Using either Hyperterminal or Minicom, log into the AlterPath PM as `admin` and type in the command

```
pm> upgrade <ipdu number>
```

If you are currently logged in as a different user, log out and then login as `admin`.

The `<ipdu number>` is the number of the IPDU to which you want to upgrade the firmware. If you have only one AlterPath PM unit, type `upgrade 1`. If you have, for instance, three units in a daisy chain, type `upgrade 3` or `upgrade 2` depending on which unit you want to upgrade.

If you have a daisy chain and you want to upgrade all units, Cyclades advises you to start from the last unit and work your way towards the first.

Upgrading the AlterPath PM Firmware

After the upgrade command is executed, the boot loader menu is displayed at the console, as shown below:

```
AlterPath PM
Copyright (c) 2002-2005 Cyclades
Corporation
V 1.7.0 Sep 15, 2005
Username: admin
Password:

pm>upgrade 1

-----
Copyright (c) 2003CycladesCorporation
AlterPathPM/KVMBootLoaderVersion1.1
-----
Boot Menu
1. Upgrade Firmware.
2. Boot Firmware.
-----
Enter choice (1 or 2):
```

3. At the boot loader menu, select the option 1 to upgrade the firmware.

The boot loader erases the firmware currently in the unit and asks you to upload the new firmware, as shown below:

```
-----
Copyright (c) 2003 Cyclades Corporation
AlterPath PM/KVM Boot Loader Version 1.1
-----
Boot Menu
1. Upgrade Firmware.
2. Boot Firmware.
-----
Enter choice (1 or 2): 1
Erasing firmware...done.
Downloading image. Please send file in 10
seconds.
```

4. Use your terminal emulator program to upload the AlterPath PM firmware file to the AlterPath PM using the Xmodem protocol.

If you are using HyperTerminal in Windows, do the following procedure:

- a. From the top menu select Transfer>Send.

The Send File popup window appears.

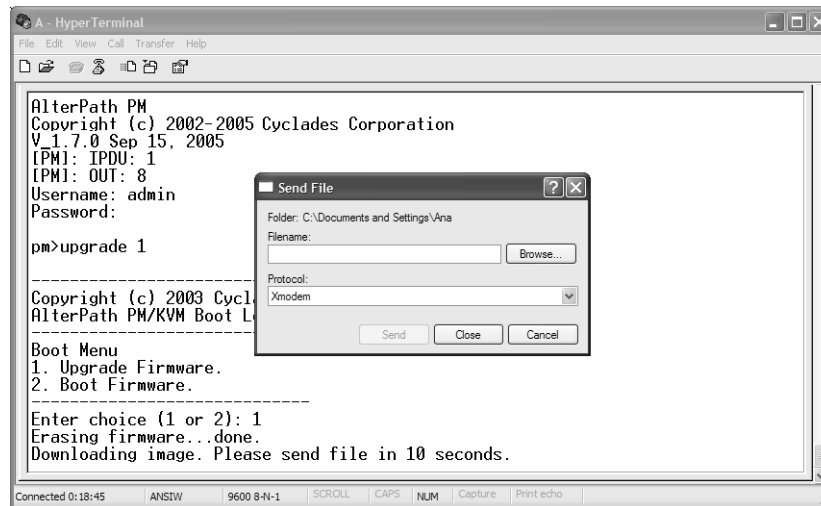

- b. Click the Browse button to set the proper path for the AlterPath PM firmware file located on your work station.

Note: You must browse for the proper file and click the Send button within 10 seconds of selecting Transfer>Send. If you fail to do so, an error message will appear and the transmission will fail. You will then be given another 10-second window in which to repeat steps b. through d.

- c. Select Xmodem as the protocol.
- d. Click on the Send button.

If you are using Minicom in Linux, do the following procedure:

- a. From the main screen, press Ctrl A + S (for sending files).

The Upload popup window appears.

If the file transfer is successful, the AlterPath PM console displays the login prompt. At this point, the upgrade process of the unit is complete; you may log into the AlterPath PM and perform actions as usual.

```
-----  
Enter choice (1 or 2): 1  
Erasing firmware...done.  
Downloading image. Please send file in 10  
seconds.done.  
V_1.2.0 - V_1.7.0 compatible  
1: Outlet turned on.  
2: Outlet turned on.  
3: Outlet turned on.  
4: Outlet turned on.  
5: Outlet turned on.  
6: Outlet turned on.  
7: Outlet turned on.  
8: Outlet turned on.  
  
AlterPath PM  
Copyright (c) 2002-2005 Cyclades  
Corporation  
V 1.7.1 Oct 4, 2005  
[PM]: IPDU: 1  
[PM]: OUT: 8  
Username:
```

If the file transfer fails, an error message appears on the AlterPath PM console, and the boot loader menu is displayed again so you can redo the process.

Upgrading the AlterPath PM Firmware

The screen would be similar to the one shown below:

```
Erasing firmware...done.
Downloading image. Please send file in 10
seconds. error.
-----
Copyright (c) 2003 Cyclades Corporation
AlterPath PM/KVM Boot Loader Version 1.1
-----
Boot Menu
1. Upgrade Firmware.
2. Boot Firmware.
-----
Enter choice (1 or 2):
```

In this case, return to Step 3. If the problem persists, contact Cyclades Technical Support for assistance.

Chapter 4

Command Line Interface

When using the AlterPath PM independently of other Cyclades products, users and administrators can access the PM command line interface through a terminal emulation program by making a console connection from a local computer to the IN port on the PM. See “To Access the Console” on page 34 for instructions.

The following sections describe the PM command line interface and the commands available to users and administrators:

- PM User Interface
- Commands

PM User Interface

You can access the PM user interface by following the instructions provided in “To Access the Console” on page 34. The menu that appears after connecting to the console depends on whether the PM has booted or not before you connect.

If you connect to the console before powering on the AlterPath PM or reboot while connected, the Boot Menu appears:

```
Boot Menu
1. Upgrade Firmware.
2. Boot Firmware.
-----
Enter choice (1 or 2):
```

If the PM has already booted before you connect to the AlterPath PM through the console, the Login prompt appears

```
AlterPath PM
Copyright (c) 2002-2005 Cyclades
Corporation
V 1.7.1 Oct 4, 2005
[PM]: IPDU: 1
[PM]: OUT: 8
Username:
```

On the Boot Menu, do one of the following options: Do nothing or enter 2 to select the Boot Firmware option. The Login prompt appears.

The line [PM]: IPDU: displays the number of PMs daisy chained. If no PMs are daisy chained, the value is 1.

The line [PM]: OUT: displays the total number of outlets on a single PM or on all daisy-chained PMs.

After the “Username:” prompt, enter your username.

After the “Password:” prompt, enter the password for the username entered.

The default user is admin with password “pm8”.

After a successful login, the PM command prompt appears after which you can use any of the commands described in “Commands” on page 52.

```
AlterPath PM
Copyright (c) 2002-2005 Cyclades
Corporation
V 1.7.1 Oct 4, 2005
[PM]: IPDU: 1
[PM]: OUT: 8
Username: admin
Password:

pm>
```

After logging in, the administrator can choose to change his or her password through the *passwd* command (seen later). Passwords can be set to null, which indicates that no password is needed.

To know all the commands supported by the PM, review the following sections or type the *help* command.

Commands

All commands are available to the admin user, and most commands are available to regular users as well.

The following commands are available to regular users and the admin user:

| Command | Page | Command | Page |
|--------------------------|-------------------------|--------------------|-------------------------|
| <i>alarm</i> | Page 53 | <i>on</i> | Page 70 |
| <i>buzzer status</i> | Page 55 | <i>passwd</i> | Page 70 |
| <i>current</i> | Page 56 | <i>reboot</i> | Page 71 |
| <i>currentprotection</i> | Page 57 | <i>restore</i> | Page 74 |
| <i>cycle</i> | Page 58 | <i>save</i> | Page 75 |
| <i>exit</i> | Page 60 | <i>status</i> | Page 76 |
| <i>factory_defaults</i> | Page 61 | <i>syslog</i> | Page 77 |
| <i>help</i> | Page 62 | <i>temperature</i> | Page 78 |
| <i>interval</i> | Page 65 | <i>unlock</i> | Page 80 |
| <i>list</i> | Page 66 | <i>ver</i> | Page 80 |
| <i>lock</i> | Page 67 | <i>whoami</i> | Page 81 |
| <i>off</i> | Page 69 | | |

The following commands are available only to the admin user:

| Command | Page | Command | Page |
|----------------|-------------------------|-----------------|-------------------------|
| <i>adduser</i> | Page 53 | <i>id</i> | Page 64 |
| <i>assign</i> | Page 54 | <i>name</i> | Page 67 |
| <i>deluser</i> | Page 59 | <i>unassign</i> | Page 79 |

adduser

Adds one username to the internal database. A maximum of eight characters (not case sensitive) is allowed, and a maximum of eight individual users is allowed. This command is available to the admin user only.

Syntax

```
adduser <user>
```

Arguments

<user> Desired username

Examples

```
pm>adduser popper
Password:
Re-enter password:
Username/password set for user popper.
pm>
```

alarm

Sets and reads the current threshold. This command is available to administrator only.

Syntax

```
alarm <IPDU#> <threshold>
```

Arguments

<IPDU#> IPDU number in a daisy chain
<threshold> The current threshold is the maximum allowed current on the power strip

Examples

To set the threshold, type:

```
pm>alarm 1 5.6  
Setting alarm threshold on IPDU #1 to 5.6A  
pm>alarm 2 7.8  
Setting alarm threshold on IPDU #2 to 7.8A
```

To read the threshold of a single unit, type:

```
pm>alarm  
Alarm threshold on IPDU #1 is 5.6A  
Alarm threshold on IPDU #2 is 7.8A
```

assign

Assigns an outlet to a given user. The user is then be able to manage such outlets. This command is available to the administrator user only.

Syntax

```
assign <outlet number> <user>
```

Arguments

<outlet number> Outlet number, such as “5”, outlet name such as “sunfire”, or group of outlets such as “1, 3-5”

<user> Desired username

Examples

To assign outlet 4, 6, 7, and 8 to user *tess*, type:

```
pm>assign 4, 6-8 tess  
4: Outlet assigned to tess.  
6: Outlet assigned to tess.  
7: Outlet assigned to tess.  
8: Outlet assigned to tess.
```

buzzer status

Displays or changes the buzzer notification status. A buzzer may when there is an overcurrent situation.

Syntax

```
buzzer status <status|on|off>
```

Arguments

| | |
|--------|----------------------------|
| status | Displays the buzzer status |
| on | Enables buzzer |
| off | Disables buzzer |

Examples

To get the current status of the buzzer notification, type:

```
pm>buzzer status  
Buzzer is ON on IPDU #1  
Buzzer is ON on IPDU #2
```

Commands

To turn on or off the buzzer notification, type:

```
pm>buzzer on  
Buzzer turned ON on IPDU #1  
Buzzer turned ON on IPDU #2  
pm>buzzer off  
Buzzer turned OFF on IPDU #1  
Buzzer turned OFF on IPDU #2
```

current

Displays the total current drawn by AlterPath PM units and the maximum current the unit has drawn (current peak). It can also be used to clear the saved peak current value.

Syntax

```
current <IPDU#> reset
```

Arguments

| | |
|---------|-------------------------------------|
| <IPDU#> | IPDU number in a daisy chain |
| reset | Clears the saved peak current value |

Examples

To get the current status for all units, type:

```
pm> current  
IPDU #1: True RMS current: 2.2A. Maximum current:  
9.4A  
IPDU #2: True RMS current: 2.0A. Maximum current:  
10.2A
```

To get the current status for a specific unit, type:

```
pm> current 2
IPDU #2: True RMS current: 2.4A. Maximum current:
10.2A
```

To reset maximum current drawn, type:

```
pm>current reset
IPDU #1: Clearing maximum recorded current to zero.
IPDU #2: Clearing maximum recorded current to zero.
```

currentprotection

Turns on and off the over current protection feature. The overcurrent protection does not let any outlet be turned on if the current drawn by the unit is greater than the current threshold configured with the command alarm. This command can also be used to display the current protection status.

Syntax

```
currentprotection <status|on|off>
```

Arguments

| | |
|--------|--|
| status | Displays the current protection status |
| on | Enables over current protection |
| off | Disables over current protection |

Examples

To display current protection status for all units, type:

```
pm>currentprotection status
IPDU #1: Overcurrent protection is OFF.
IPDU #2: Overcurrent protection is OFF.
```

Commands

To enable current protection status for all units, type:

```
pm>currentprotection ON  
IPDU #1: Overcurrent protection turned ON.  
IPDU #2: Overcurrent protection turned ON.
```

To disable current protection status for all units, type:

```
pm>currentprotection off  
IPDU #1: Overcurrent protection turned OFF.  
IPDU #2: Overcurrent protection turned OFF.
```

cycle

Power cycles an outlet or groups of outlets. You can use the outlet number or the outlet name (see command name for details).

Syntax

```
cycle all|<outlet number>
```

Arguments

| | |
|-----------------|---|
| all | Turns off all outlets |
| <outlet number> | Outlet number, such as “5”, outlet name such as “sunfire”, or group of outlets such as “1, 3-5” |

Examples

To cycle one outlet, type:

```
pm> cycle 3  
3: Outlet turned off.  
3: Outlet turned on.
```

To cycle multiple outlets, type:

```
pm>cycle 2, 3, 5-7
2: Outlet turned off.
3: Outlet turned off.
5: Outlet turned off.
6: Outlet turned off.
7: Outlet turned off.
2: Outlet turned on.
3: Outlet turned on.
5: Outlet turned on.
6: Outlet turned on.
7: Outlet turned on.
```

deluser

Deletes one username from the internal database. This command is available to the administrative user *only*.

Syntax

```
deluser <user>
```

Arguments

<user> Desired username

Examples

To delete the user *rog*, type:

```
pm>deluser rog
Username deleted.
```

Commands

exit

Exits the session.

Syntax

exit

Arguments

N/A

Examples

To exit the current session, type:

```
pm>exit

AlterPath PM
Copyright (c) 2002-2005 Cyclades
Corporation
V 1.7.1 Oct 4, 2005
Username:
```

factory_defaults

Resets the unit to its factory configuration so that all outlets are on, unlocked, unnamed, and no users are created. When used with a daisy chain, this command resets all units in the chain.

Syntax

```
factory_defaults
```

Arguments

N/A

Examples

To reset the factory defaults, type:

```
pm>factory_defaults
Setting configuration to defaults on IPDU
#1
1: Outlet turned on.
2: Outlet turned on.
3: Outlet turned on.
4: Outlet turned on.
5: Outlet turned on.
6: Outlet turned on.
7: Outlet turned on.
8: Outlet turned on.
Saving configuration to flash on IPDU #1
... done.
```

help

Displays the system help message for all commands or for a single command when specified.

Syntax

`<command> help`

or

`help`

Arguments

`<command>` Any available command

Examples

To view the system help message for a specific command, type the command and then type “help”:

```
pm>syslog help  
Usage: syslog on | off  
Turn the syslog messages on the console on or off
```

To view the system help message for all commands, type:

```

pm>help

Available commands:
cycle                deluser              factory_defaults
interval            list                 lock
help                name                 off
on                  passwd               reboot
restore             save                 status
syslog              temperature          ver
unassign            unlock               whoami
buzzer              current              currentprotection
adduser             alarm                assign
id

NOTE: To get detailed help on the commands listed
above type
      '<command> help';
NOTE: Some commands accept as input a data type
called
      <outletString>. <outletString> is a string
representing
one or more outlets. This string can be:
- one single outlet.
  Examples: on 3 (turn on outlet 3);
            off router (turn off the outlet
called
            router).
- a group of outlets.
  Examples: status 1,3,5 (get status of outlets
1,
            3 and 5);
            cycle 2-7 (cycle the outlets 2, 3, 4,
            5, 6, 7)
            lock 2,5-7 (lock the outlets 2, 5, 6
            and 7).

```

id

Sets or displays the ID of a PM unit that you are directly connected to. A maximum of eight characters (not case sensitive) is allowed. Spaces, numbers, and special characters are allowed.

This command is available to the administrator user only.

This command does not work in a daisy chain.

Syntax

```
id <PM name>
```

or

```
id
```

Arguments

<PM name> Desired name of the PM

Examples

To set a PM ID to *RDservers*, type:

```
pm>id RDservers  
PM id = RDservers
```

To display the name of the connected PM, type:

```
pm>id  
PM id = RDservers
```

interval

Configures the power up interval for each outlet in the system. The power up interval of an outlet is the time the unit will wait, after turning this outlet on, to turn on any other outlet.

Syntax

```
interval <outlet number> <duration>
```

Arguments

<duration> Sets the power up interval of outlets.
Default value is 0.5.

<outlet number> Outlet number, such as “5”, outlet name such as “sunfire”, or group of outlets such as “1, 3-5”

Examples

To display the interval, type:

```
pm>interval 1
```

To set the interval, type:

```
pm>interval 2, 4-6 2.4
2: Outlet cycle interval set to 2.40.
4: Outlet cycle interval set to 2.40.
5: Outlet cycle interval set to 2.40.
6: Outlet cycle interval set to 2.40.
```

list

List users created and outlets assigned to each user (for the administrator), or just the outlets assigned to the user logged in at the moment (for the regular user).

Syntax

```
list
```

Arguments

N/A

Examples

To list user names in the internal database, type:

```
pm>list
-----
User          Outlets
-----
kant          1,5
diderot       2,6
russel        3,7
tao           4,8
-----
```

To list the usernames in the internal database, type:

```
pm>list
-----
User          Outlets
-----
kant          1,5
-----
pm>
```

lock

Locks an outlet or group of outlets in the current state. The response to this command is a list of status lines, one per power port.

Syntax

```
lock <outlet number>
```

Arguments

<outlet number> Outlet number, such as “5”, outlet name such as “sunfire”, or group of outlets such as “1, 3-5”

Examples

To lock outlets 1, 2, and 6, type:

```
pm>lock 2,6,1
1: Outlet locked.
2: Outlet locked.
6: Outlet locked.
```

name

Names an outlet. A maximum of 16 alphabetic and numeric characters (not case sensitive) is allowed with these exceptions:

- The hyphen (-), percent (%), and comma (,) characters are not allowed.
- Numeric characters are not allowed as the first character of a name.

This command is available to the administrator user only.

Syntax

```
name <outlet number> <name>
```

Commands

Arguments

`<outlet number>` Outlet number, such as “5”
`<name>` Desired outlet name

Examples

To name outlet 4 as *nowhere*, type:

```
pm>name 4 nowhere  
4: Outlet now named nowhere
```

off

Turns an outlet or group of outlets off.

Syntax

```
off all|<outlet number>
```

Arguments

`all` Turns off all outlets

`<outlet number>` Outlet number, such as “5”, outlet name such as “sunfire”, or group of outlets such as “1, 3-5”

Examples

To turn all outlets off, type:

```
pm>off all  
1: Outlet turned off.  
2: Outlet turned off.  
3: Outlet turned off.  
4: Outlet turned off.  
5: Outlet turned off.  
6: Outlet turned off.  
7: Outlet turned off.  
8: Outlet turned off.
```

To turn off all outlets but 1 and 8, type:

```
pm>off 2-7  
2: Outlet turned off.  
3: Outlet turned off.  
4: Outlet turned off.  
5: Outlet turned off.  
6: Outlet turned off.  
7: Outlet turned off.
```

on

Turns an outlet or a group of outlets on. If more than one outlet is selected there will be an interval between outlets being powered on, the interval is defined by the `interval` command.

Syntax

```
on all|<outlet number>
```

Arguments

`all` Turns off all outlets

`<outlet number>` Outlet number, such as “5”, outlet name such as “sunfire”, or group of outlets such as “1, 3-5”.

Examples

To turn on outlets 1, 3, 4, and 5, type:

```
pm>on 1, 3-5
1: Outlet turned on.
3: Outlet turned on.
4: Outlet turned on.
5: Outlet turned on.
```

passwd

Sets a password. The Administrator has a default password (pm8), which can be changed. Regular users can change or set only their own password. The Administrator can change his or her own password or any regular user’s password.

Syntax

```
passwd <newpassword>
```

Arguments

<newpassword> A maximum of eight characters (not case sensitive) is allowed.

Examples

To change the password for user *alpha*, type:

```
pm>passwd alpha
Password:
Re-enter password:
Username/password set for user alpha.
```

To change the admin password, type:

```
pm>passwd
Password: <new password>
Re-enter password:
Username/password set for user admin.
```

reboot

Reboots the PM units. You can also reboot a specific unit number. Issuing the reboot command with out a parameter reboots the first unit in a chain, not all the units in a chain.

Syntax

```
reboot
```

or

```
reboot <IPDU#>
```

Arguments

<IPDU#> IPDU number in a daisy chain

Examples

To reboot the first unit of the chain, or to reboot the unit in stand alone mode, type:

```
pm>reboot

-----
Copyright (c) 2005 Cyclades Corporation
PM/KVM Boot Loader Version 1.1
-----

Boot Menu
1. Upgrade Firmware.
2. Boot Firmware.
-----

Enter choice (1 or 2): Timeout...
Booting...

Starting AlterPath PM
Retrieving configuration

1: Outlet turned on.
2: Outlet turned on.
3: Outlet turned on.
4: Outlet turned on.
5: Outlet turned on.
6: Outlet turned on.
7: Outlet turned on.
8: Outlet turned on.

AlterPath PM
Copyright (c) 2002-2005 Cyclades Corporation
V 1.7.1 Oct 4, 2005

[PM]: IPDU: 1
[PM]: OUT: 8
Username:
```

To reboot the a specific IPDU in the chain, type:

```
pm>reboot 4

-----
Copyright (c) 2005 Cyclades Corporation
PM/KVM Boot Loader Version 1.1
-----

Boot Menu
1. Upgrade Firmware.
2. Boot Firmware.
-----

Enter choice (1 or 2): Timeout...
Booting...

Starting AlterPath PM
Retrieving configuration

1: Outlet turned on.
2: Outlet turned on.
3: Outlet turned on.
4: Outlet turned on.
5: Outlet turned on.
6: Outlet turned on.
7: Outlet turned on.
8: Outlet turned on.

AlterPath PM
Copyright (c) 2002-2005 Cyclades Corporation
V 1.7.1 Oct 4, 2005

[PM]: IPDU: 4
[PM]: OUT: 8
Username:
```

restore

Restores the configuration currently saved in flash.

Syntax

```
restore
```

Arguments

N/A

Examples

To restore the configuration currently saved in flash, type:

```
pm>restore  
1: Outlet turned on.  
2: Outlet turned on.  
3: Outlet turned on.  
4: Outlet turned on.  
5: Outlet turned on.  
6: Outlet turned on.  
7: Outlet turned on.  
8: Outlet turned on.
```

save

Saves the current configuration in the flash device built in to all AlterPath PM units. This command saves the username/password database and the specific information pertaining to each outlet such as outlet name, outlet assignments, outlet state.

If you save your configuration to flash it will be restored after the next reboot. If you do not save your configuration to flash you will lose it all after the next reboot.

Syntax

```
save
```

Arguments

N/A

Examples

To save the configuration to flash, type:

```
pm>save  
Saving configuration to flash on IPDU #1 ... Done.  
Saving configuration to flash on IPDU #2 ... Done.
```

An error message will be displayed if there is an error while writing the configuration to flash.

status

Displays the status of selected outlets.

Syntax

```
status <outlet number>
```

Arguments

<outlet number> Outlet number, such as “5”, outlet name such as “sunfire”, or group of outlets such as “1, 3-5”

Examples

```
pm>status 1
Outlet  Name      Status      Interval (s)  Users
1       linux    Unlocked ON  0.50          nei
```

syslog

Displays or changes the syslog notification status.

Syntax

```
syslog on|off
```

Arguments

| | |
|-----|--|
| on | Enables message to be displayed in the console when there is an over current situation |
| off | Disables the message notification |

Examples

To get the current status of the syslog notification use `syslog`, type:

```
pm>syslog  
Syslog is ON on IPDU #1  
Syslog is ON on IPDU #2
```

To turn on and off the syslog notification use `syslog on` or `syslog off` type:,

```
pm>syslog on  
Syslog turned ON on IPDU #1  
Syslog turned ON on IPDU #2  
pm>syslog off  
Syslog turned OFF on IPDU #1  
Syslog turned OFF on IPDU #2
```

temperature

This command displays the AlterPath PM unit's surrounding temperature and the maximum temperature the unit has registered (temperature peak). It can also be used to clear the saved peak temperature value.

Syntax

```
temperature <IPDU#>|reset
```

Arguments

| | |
|---------|---|
| <IPDU#> | IPDU number in a daisy chain |
| reset | Resets the maximum temperature registered |

Examples

To get the temperature for all units in a daisy chain, type:

```
pm> temperature
IPDU #1: Temperature: 36.1°C (96.9°F). Maximum:
36.1°C (96.9°F).
IPDU #2: Temperature: 20.0°C (68.0°F). Maximum:
25.0°C (77.0°F).
```

To get the temperature for specific unit, provide the unit number as an argument, type:

```
pm> temperature 2
IPDU #2: Temperature: 20.0°C (68.0°F). Maximum:
25.0°C (77.0°F)
```

To reset the maximum temperature registered, use `reset` as a argument, type:

```
pm>>temperature reset  
IPDU #1: Clearing maximum recorded temperature to  
zero.  
IPDU #2: Clearing maximum recorded temperature to  
zero.
```

unassign

Removes the assignment of an outlet or group of outlets from a given user. This command is available to the administrator user only.

Syntax

```
unassign <outlets> <user>
```

Arguments

<outlet number> Outlet number, such as “5”, outlet name such as “sunfire”, or group of outlets such as “1, 3-5”

<user> Desired username

Examples

To unassign outlet 2 and 4 from user *diderot*, type:

```
pm>>unassign 2,4 diderot  
2: Outlet no longer assigned to diderot.  
4: Outlet no longer assigned to diderot.
```

unlock

Unlocks an outlet or group of outlets in the current state. The response to this command is a list of status lines, one per power port.

Syntax

```
unlock <outlet number>
```

Arguments

<outlet number> Outlet number, such as “5”, outlet name such as “sunfire”, or group of outlets such as “1, 3-5”

Examples

To unlock outlets 2, 3, and 8, type:

```
pm>unlock 2,3,8
2: Outlet unlocked.
3: Outlet unlocked.
8: Outlet unlocked.
```

ver

Shows the current software version.

Syntax

```
ver <IPDU#>
```

Arguments

<IPDU#> IPDU number in a daisy chain

Examples

To view the current software version of all IPDUs in a daisy chain, type:

```
pm>ver
IPDU #1: Hw with 8 outlets 20 AMPs max Sw V
1.7.1 Oct 4, 2005 id RDservers
IPDU #2: Hw with 10 outlets 10 AMPs max Sw
V 1.7.1 Oct 4, 2005 id
```

Note: If an IPDU has an id assigned to it, the `ver` command displays the word “id” followed by the name of the IPDU; however, if no id is configured for the IPDU, the `ver` command displays the word “id” without a name following it.

To get this information for a specific unit, provide the unit number as an argument.

```
pm>ver 2
IPDU #2: Hw with 10 outlets 10 AMPs max Sw
V 1.7.1 Oct 4, 2005 id
```

whoami

Shows the username of the user currently logged in.

Syntax

```
whoami
```

Arguments

N/A

Commands

Examples

To view the current username, type:

```
pm>whoami  
admin
```

Appendix A

Specifications

The following sections describe the hardware and electrical specifications for each PM model:

- “Electrical and Hardware Specifications” on page 84
- “Interface Pinouts” on page 96

Electrical and Hardware Specifications

The following tables list the electrical specifications for each AlterPath PM model.

The following table lists the specifications for the AlterPath PM8-15A.

Table A-1: PM8-15A Specifications

| Characteristics | Specifications |
|--|-------------------------------------|
| Input Voltage | 100-125 VAC |
| Max Output Current Total | 15A (de-rated to 12A) |
| Max Output Current Each Outlet | 15A (de-rated to 12A) |
| Operating Temperature | 50-122 °F/10-50 °C |
| Relative Humidity | 5%-95% |
| Weight | 6.1 lb (2.8 kg) |
| Physical Dimensions (W x D x H) | 39.6 x 1.7 x 2.2 /100.6 x 4.3 x 5.6 |

The following table lists the specifications for the AlterPath PM8-20A and AlterPath PM8-L20A.

Table A-2: PM8-20A and PM8-L20A Specifications

| Characteristics | Specifications |
|--|---|
| Input Voltage | 100-125 VAC |
| Max Output Current Total | 20A (de-rated to 16A) |
| Max Output Current Each Outlet | 15A (de-rated to 12A) |
| Operating Temperature | 50-122 °F (10-50 °C) |
| Relative Humidity | 5%-95% |
| Weight | 6.1 lb (2.8 kg) |
| Physical Dimensions (W x D x H) | 39.6 x 1.7 x 2.2 in (100.6 x 4.3 x 5.6 cm) |

The following table lists the specifications for the AlterPath PM8i-10.

Table A-3: PM8i-10A Specifications

| Characteristics | Specifications |
|--|---|
| Input Voltage | 100-240 VAC |
| Max Output Current Total | 10A |
| Max Output Current Each Outlet | 10A |
| Operating Temperature | 50-122 °F (10-50 °C) |
| Relative Humidity | 5%-95% |
| Weight | 5 lb (2.3 kg) |
| Physical Dimensions (W x D x H) | 17 x 3.7 x 2.63 in (43.2 x 9.4 x 6.7 cm) |

The following table lists the specifications for the AlterPath PM10-15A.

Table A-4: PM10-15A Specifications

| Characteristics | Specifications |
|--|---|
| Input Voltage | 100-125 VAC |
| Max Output Current Total | 15A (de-rated to 12A) |
| Max Output Current Each Outlet | 15A (de-rated to 12A) |
| Operating Temperature | 50-122 °F (10-50 °C) |
| Relative Humidity | 5%-95% |
| Weight | 7.8 lb (3.5 kg) |
| Physical Dimensions (W x D x H) | 1.75 x 8 x 9 in (4.4 x 20.3 x 22.9 cm) |

The following table lists the specifications for the AlterPath PM10-20A and PM10-L20A.

Table A-5: PM10-20A and PM10-L20A Specifications

| Characteristics | Specifications |
|--|---|
| Input Voltage | 100-125 VAC |
| Max Output Current Total | 20A (de-rated to 16A) |
| Max Output Current Each Outlet | 15A (de-rated to 12A) |
| Operating Temperature | 50-122 °F (10-50 °C) |
| Relative Humidity | 5%-95% |
| Weight | 8.4 lb (3.8 kg) |
| Physical Dimensions (W x D x H) | 1.75 x 8 x 9 in (4.4 x 20.3 x 22.9 cm) |

The following table lists the specifications for the AlterPath PM10-L30A.

Table A-6: PM10-L30A Specifications

| Characteristics | Specifications |
|---------------------------------------|-----------------------|
| Input Voltage | 100-125 VAC |
| Max Output Current Total | 30A (de-rated to 24A) |
| Max Output Current Each Outlet | 15A (de-rated to 12A) |
| Operating Temperature | 50-122 °F (10-50 °C) |
| Relative Humidity | 5%-95% |

Table A-6: PM10-L30A Specifications *(Continued)*

| Characteristics | Specifications |
|--|---|
| Weight | 9 lb (4 kg) |
| Physical Dimensions (W x D x H) | 1.75 x 8 x 9 in (4.4 x 20.3 x 22.9 cm) |

The following table lists the specifications for the AlterPath PM10i-10A.

Table A-7: PM10i-10A Specifications

| Characteristics | Specifications |
|--|--|
| Input Voltage | 100-240 VAC |
| Max Output Current Total | 10A |
| Max Output Current Each Outlet | 10A |
| Operating Temperature | 50-122 °F (10-50 °C) |
| Relative Humidity | 5%-95% |
| Weight | 5 lb (2.3 kg) |
| Physical Dimensions (W x D x H) | 19 x 8 x 1.75 in (48.3 x 20.3 x 4.4 cm) |

The following table lists the specifications for the AlterPath PM10i-15A.

Table A-8: PM10i-15A Specifications

| Characteristics | Specifications |
|---------------------------------------|-----------------------|
| Input Voltage | 100-240 VAC |
| Max Output Current Total | 15A (de-rated to 12A) |
| Max Output Current Each Outlet | 10A (de-rated to 8A) |

Table A-8: PM10i-15A Specifications *(Continued)*

| Characteristics | Specifications |
|--|--|
| Operating Temperature | 50-122 °F (10-50 °C) |
| Relative Humidity | 5%-95% |
| Weight | 7.8 lb (3.5 kg) |
| Physical Dimensions (W x D x H) | 19 x 8 x 1.75 in (48.3 x 20.3 x 4.4 cm) |

The following table lists the specifications for the AlterPath PM10i-16A.

Table A-9: PM10i-16A Specifications

| Characteristics | Specifications |
|--|--|
| Input Voltage | 100-240 VAC |
| Max Output Current Total | 16A |
| Max Output Current Each Outlet | 10A |
| Operating Temperature | 50-122 °F (10-50 °C) |
| Relative Humidity | 5%-95% |
| Weight | 8.4 lb (3.8 kg) |
| Physical Dimensions (W x D x H) | 19 x 8 x 1.75 in (48.3 x 20.3 x 4.4 cm) |

Electrical and Hardware Specifications

The following table list the electrical specifications for the AlterPath PM10i-20A.

Table A-10: PM10i-20A Specifications

| Characteristics | Specifications |
|--|--|
| Input Voltage | 100-240 VAC |
| Max Output Current Total | 20A (de-rated to 16A) |
| Max Output Current Each Outlet | 10A (de-rated to 8A) |
| Operating Temperature | 50-122 °F (10-50 °C) |
| Relative Humidity | 5%-95% |
| Weight | 8.4 lb (3.8 kg) |
| Physical Dimensions (W x D x H) | 19 x 8 x 1.75 in (48.3 x 20.3 x 4.4 cm) |

The following table lists the specifications for the AlterPath PM10i-32A and PM10i-32Au model.

Table A-11: PM10i-32A and PM10i-32Au Specifications

| Characteristics | Specifications |
|---------------------------------------|-----------------------|
| Input Voltage | 100-240 VAC |
| Max Output Current Total | 32A |
| Max Output Current Each Outlet | 10A |
| Operating Temperature | 32-122 °F (0-50 °C) |
| Relative Humidity | 5%-95% |

Table A-11: PM10i-32A and PM10i-32Au Specifications (*Continued*)

| Characteristics | Specifications |
|--|---|
| Weight | 8.4 lb (3.8 kg) |
| Physical Dimensions (W x D x H) | 19 x 1.75 x 11.5 in (48.3 x 4.4 x 29.2 cm) |

The following table lists the specifications for the AlterPath PM10i-L30A model.

Table A-12: PM10i-L30A Specifications

| Characteristics | Specifications |
|--|---|
| Input Voltage | 100-240 VAC |
| Max Output Current Total | 30A (de-rated to 24A) |
| Max Output Current Each Outlet | 10A (de-rated to 8A) |
| Operating Temperature | 32-122 °F (0-50 °C) |
| Relative Humidity | 5%-95% |
| Weight | 8.4 lb (3.8 kg) |
| Physical Dimensions (W x D x H) | 19 x 1.75 x 11.5 in (48.3 x 4.4 x 29.2 kg) |

Electrical and Hardware Specifications

The following table lists the specifications for the AlterPath PM20-20A and PM20-L20A models.

Table A-13: PM20-20A and PM20-L20A Specifications

| Characteristics | Specifications |
|--|---|
| Input Voltage | 100-125 VAC |
| Max Output Current Total | 20A (de-rated to 16A) |
| Max Output Current Each Outlet | 15A (de-rated to 12A) |
| Operating Temperature | 50-122 °F (10-50 °C) |
| Relative Humidity | 5%-95% |
| Weight | 6.1 lb (2.8 kg) |
| Physical Dimensions (W x D x H) | 1.8 x 2.2 x 66 in (4.6 x 5.6 x 167.6 cm) |

The following table lists the specifications for the AlterPath PM20-L30A model.

Table A-14: PM20-L30A Specifications

| Characteristics | Specifications |
|---------------------------------------|-----------------------|
| Input Voltage | 100-125 VAC |
| Max Output Current Total | 30A (de-rated to 24A) |
| Max Output Current Each Outlet | 15A (de-rated to 12A) |
| Operating Temperature | 50-122 °F (10-50 °C) |
| Relative Humidity | 5%-95% |

Table A-14: PM20-L30A Specifications *(Continued)*

| Characteristics | Specifications |
|--|---|
| Weight | 6.1 lb (2.8 kg) |
| Physical Dimensions (W x D x H) | 1.8 x 2.2 x 66 in (4.6 x 5.6 x 167.6 cm) |

The following table lists the specifications for the AlterPath PM20i-16A.

Table A-15: PM20i-16A Specifications

| Characteristics | Specifications |
|--|---|
| Input Voltage | 100-240VAC |
| Max Output Current Total | 16A |
| Max Output Current Each Outlet | 10A |
| Operating Temperature | 32-122 °F (0-50 °C) |
| Relative Humidity | 5%-95% |
| Weight | 13.5 lb (6.1 kg) |
| Physical Dimensions (W x D x H) | 2.2 x 2.8 x 66 in (5.6 x 7.1 x 167.6 cm) |

Electrical and Hardware Specifications

The following table lists the specifications for the AlterPath PM20i-20A and PM20i-L20A.

Table A-16: PM20i-20A and PM20i-L20A Electrical Specifications

| Characteristics | Specifications |
|--|---|
| Input Voltage | 100-240 VAC |
| Max Output Current Total | 20A (de-rated to 16A) |
| Max Output Current Each Outlet | 10A (de-rated to 8A) |
| Operating Temperature | 32-122 °F (0-50 °C) |
| Relative Humidity | 5%-95% |
| Weight | 13.5 lb (6.1 kg) |
| Physical Dimensions (W x D x H) | 2.2 x 2.8 x 66 in (5.6 x 7.1 x 167.6 cm) |

The following table lists the specifications for the AlterPath PM20i-L30A model.

Table A-17: PM20i-L30A Specifications

| Characteristics | Specifications |
|---------------------------------------|-----------------------|
| Input Voltage | 100-240 VAC |
| Max Output Current Total | 30A (de-rated to 24A) |
| Max Output Current Each Outlet | 10A (de-rated to 8A) |
| Operating Temperature | 32-122 °F (0-50 °C) |
| Relative Humidity | 5%-95% |

Table A-17: PM20i-L30A Specifications *(Continued)*

| Characteristics | Specifications |
|--|---|
| Weight | 13.5 lb (6.1 kg) |
| Physical Dimensions (W x D x H) | 2.2 x 2.8 x 66 in (5.6 x 7.1 x 167.6 cm) |

The following table lists the specifications for the AlterPath PM20i-32A and AlterPath PM20i-32Au models.

Table A-18: PM20i-32A and PM20i-32Au Specifications

| Characteristics | Specifications |
|--|---|
| Input Voltage | 100-240 VAC |
| Max Output Current Total | 32A |
| Max Output Current Each Outlet | 10A |
| Operating Temperature | 50-122 °F (10-50 °C) |
| Relative Humidity | 5%-95% |
| Weight | 6.1 lb (2.8 kg) |
| Physical Dimensions (W x D x H) | 1.8 x 2.2 x 66 in (4.6 x 5.6 x 167.6 cm) |

Interface Pinouts

The following table illustrates the AlterPath PM's pinouts for the In and OUT RS-232 serial ports (RJ-45F connectors).

Table A-19: Pinouts for In and OUT RS-232 serial ports

| Signal | Name/Function | I/O | In Pin | OUT Pin |
|---------------|----------------------|------------|---------------|----------------|
| RTS | Request to Send | (O) | 5 | 1 |
| DTR | Data Terminal Ready | (O) | 7 | 2 |
| TxD | Transmit Data | (O) | 6 | 3 |
| Gnd | Ground | N/A | 4 | 4 |
| CTS | Clear to Send | (I) | 1 | 5 |
| RxD | Receive Data | (I) | 3 | 6 |
| DCD | Data Carrier Detect | (I) | 2 | 7 |
| DSR | Data Set Ready | (I) | 8 | 8 |

Appendix B

Safety Instructions

Follow the safety precautions in this document when installing and operating the AlterPath PM. See the following instructions:

- “Safety Instructions” on page 98
- “Sicherheitsanweisungen” on page 99
- “Istruzioni di Sicurezza” on page 100
- “Instruções de Segurança” on page 102
- “Instrucciones de seguridad” on page 103
- “Instructions de sécurités” on page 105
- “FCC Warning Statement” on page 106
- “Canadian DOC Notice” on page 106

Safety Instructions

Read all the following safety guidelines to protect yourself and your AlterPath PM.

DANGER! All outlets of the AlterPath PM output high voltage. Necessary precautions should be taken.

DANGER! To help prevent electric shock, plug the AlterPath PM into a properly grounded power source. The power cord is equipped with a three-prong plug to help ensure proper grounding. Do not use adapter plugs or remove the grounding prong from the cable. Do not use extension cords with the AlterPath PM.

DANGER! Do not push any objects through the openings of the AlterPath PM. Doing so can cause fire or electric shock by shorting out interior components.

DANGER! There is a possibility of live feed for either Line or Neutral even if one of the circuit breakers is disabled.

Important: AlterPath PM is intended for enterprise and indoor use only.

Important: To help protect the AlterPath PM from electrical power fluctuations, use a surge suppressor, line conditioner, or uninterruptible power supply.

Important: Be sure that nothing rests on the cables of the AlterPath PM and that they are not located where they can be stepped on or tripped over.

Important: Do not spill food or liquids on the AlterPath PM. If it gets wet, disconnect the power immediately and contact Cyclades.

Important: Keep your AlterPath PM away from heat sources.

Sicherheitsanweisungen

Bitte lesen und befolgen Sie diese Sicherheitsrichtlinien um sich und Ihren AlterPath PM vor Schäden zu bewahren.

GEFAHR! There is a possibility of live feed for either Line or Neutral even if one of the circuit breakers is disabled.

GEFAHR! Alle Ausgänge des AlterPath PM führen Hochspannung. Bitte die erforderlichen Vorsichtsmaßnahmen einhalten.

GEFAHR! Um elektrische Stromschläge zu vermeiden, verbinden Sie bitte das Eingangskabel des AlterPath PM mit einer ausreichend geerdeten Stromversorgung. Das Netzkabel ist mit drei Leitungen versehen um korrekte Erdung zu ermöglichen. Bitte benutzen Sie keine Adapterstecker und entfernen Sie nicht die Erdungsleitung. Bitte verwenden Sie keine Verlängerungskabel.

GEFAHR! Bitte führen Sie keine Gegenstände in die Öffnungen des AlterPath PM ein. Dies könnte zu Bränden oder elektrischen Schock durch Kurzschluss der internen Komponenten führen.

GEFAHR! Auch nach Öffnung einer der beiden Sicherungen kann das Gerät noch unter Spannung über die Phasen- oder Nullleiterzufuhr stehen.

Wichtig: Der AlterPath PM ist für den Unternehmenseinsatz und den Gebrauch innerhalb von abgeschlossenen Gebäuden vorgesehen.

Wichtig: Um den AlterPath PM vor elektrischen Spannungsschwankungen zu schützen empfehlen wir den Einsatz von Überspannungsreglern, Spannungsglätttern oder USVs.

Wichtig: Bitte stellen Sie sicher, daß keine Gegenstände auf den Kabeln des AlterPath PM liegen und die Kabel so geführt sind, daß niemand darauf treten oder darüber stolpern kann.

Wichtig: Bitte schütten Sie keine Nahrungsmittel oder Flüssigkeiten auf den AlterPath PM. Falls das Gerät naß werden sollte trennen Sie bitte sofort die Netzverbindung und kontaktieren Cyclades.

Wichtig: Bitte halten Sie Ihren AlterPath PM vor Hitzequellen entfernt.

Istruzioni di Sicurezza

Vi preghiamo di attenervi alle seguenti direttive per la vostra sicurezza e un sicuro utilizzo dell'AlterPath PM.

PERICOLO! Tutte le prese dell'AlterPath PM sono sotto alta tensione. Occorre prendere precauzioni.

PERICOLO! Per evitare di prendere la scossa, inserire la spina dell'AlterPath PM nell'appropriata presa a terra. L'alimentatore è equipaggiato con una spina a tre poli per assicurare un corretto collegamento. Non utilizzare adattatori e non rimuovere la spina a tre poli dal cavo. Non utilizzare prolunghe.

PERICOLO! Non inserire oggetti nelle aperture dell'AlterPath PM. Farlo potrebbe causare un incendio o danneggiare i componenti interni.

PERICOLO! C'è la possibilità che la fase o la terra rimanga sotto tensione anche se uno degli interruttori è disattivato.

Importante: L'AlterPath PM è certificato per uso aziendale e solamente in luogo chiuso.

Importante: Per proteggere l'AlterPath PM da fluttuazioni di corrente elettrica, utilizzare un limitatore di sovracorrente, un condizionatore di linea, o un gruppo di alimentazione continua, UPS.

Importante: Assicurarsi che niente giaccia sui cavi dell'AlterPath PM e che questi non causino intralcio al passaggio.

Importante: Non versare cibo o liquidi sull'AlterPath PM. Nel caso l'apparecchiatura si bagnasse, togliere immediatamente l'alimentazione e contattare Cyclades.

Importante: Tenere lontano da fonti di calore.

Instruções de Segurança

Leia e siga as diretrizes de segurança abaixo para sua proteção e de seu AlterPath PM.

PERIGO! Alta voltagem está presente em todas as tomadas do AlterPath PM. As devidas precauções devem ser tomadas.

PERIGO! Para evitar choques elétricos, conecte o AlterPath PM a uma tomada devidamente aterrada. O cabo de força possui uma tomada com três pinos para ajudar a garantir que o devido aterramento seja feito. Não use adaptadores nem remova o pino de aterramento da tomada. Não use extensões para conexão elétrica com o AlterPath PM.

PERIGO! Não introduza objetos pelas aberturas existentes no AlterPath PM. O curto-circuito de componentes internos pode fazer com que o produto pegue fogo e causar choques elétricos.

PERIGO! É possível que haja tensão presente nos circuitos de fase ou neutro mesmo que um dos dispositivos de proteção contra sobrecorrente esteja atuando.

Importante: O AlterPath PM é destinado exclusivamente ao uso comercial em ambientes fechados.

Importante: Para ajudar a proteger o AlterPath PM contra conseqüências nocivas causadas por flutuações na rede elétrica, use um estabilizador, filtro ou baterias que evitem eventual interrupção no fornecimento de energia.

Importante: Garanta que não haja nenhum objeto sobre os cabos do AlterPath PM e que eles não estejam em locais de transito de pessoas para que não sejam pisados e para que não causem quedas ou accidentes.

Importante: Não derrame alimentos ou líquidos sobre o AlterPath PM. Se o produto for molhado, desconete-o da tomada imediatamente e entre em contato com a Cyclades.

Importante: Mantenha o AlterPath PM longe de fontes de calor.

Instrucciones de seguridad

Lea y siga estas pautas de seguridad para protegerse a usted y a su AlterPath PM.

¡PELIGRO! Todos los enchufes de salida AlterPath PM tienen alto voltaje. Se deben tomar las precauciones necesarias.

¡PELIGRO! Para ayudar a prevenir descargas eléctricas, conecte el AlterPath PM en una fuente de energía correctamente puesta a tierra. El cable eléctrico está equipado de un enchufe del tres conectores para ayudar a asegurar la puesta a tierra apropiadamente. No utilice adaptadores de enchufe, ni quite el conector de tierra. No utilice extensores con el AlterPath PM.

¡PELIGRO! No empuje ningún objeto en las aberturas del AlterPath PM. El hacerlo puede causar fuego o descargas eléctricas poniendo en cortocircuito los componentes interiores.

¡PELIGRO! Existe la posibilidad de tensión en cualquier conector del PM, incluso si uno de los interruptores esta desabilitado.

Importante: El AlterPath PM se piensa para la empresa y el uso de interior solamente.

Importante: Para ayudar a proteger el AlterPath PM contra fluctuaciones de la corriente eléctrica, utilice un supresor de fluctuaciones, acondicionador de línea, o fuente de alimentación ininterrumpida.

Importante: Asegurese que nada se apoya sobre los cables del AlterPath PM y que no están localizados donde puedan ser pisados cuando esten encendidos.

Importante: No derrame alimentos o líquidos en el AlterPath PM. Si se hubiera mojado, desconecte la energía inmediatamente y entre en contacto con Cyclades.

Importante: Mantenga su AlterPath PM lejos de fuentes de calor.

Instructions de sécurités

Lisez et suivez les instructions de sécurité pour votre protection et celle de l'AlterPath PM.

DANGER! Toutes les prises de l'AlterPath PM produisent une tension électrique élevée. Prenez les précautions d'usage.

DANGER! Pour aider à éviter tout choc électrique, branchez l'AlterPath PM à une source électrique correctement liée à la terre. Le cordon électrique est équipé d'une prise à 3 broches pour aider à assurer une connexion correcte avec la terre. N'utilisez pas d'adaptateurs ou n'enlevez pas la broche de la terre du cable. N'utilisez pas de rallonge électrique avec l'AlterPath PM.

DANGER! Ne pas faire passer aucun objets à travers les ouvertures de l'AlterPath PM. Le faire peut causer un feu ou des chocs électriques en court-circuitant des composants interne.

DANGER! Il y a une possibilité de présence de courant pour la Phase et le Neutre même si l'un des relais électrique est désactivé.

Important: L'AlterPath PM est prévu pour les entreprises dans un usage à l'intérieur seulement.

Important: Pour aider à protéger l'AlterPath PM des fluctuations d'alimentation électrique, utilisez un filtre de surtension, un conditionneur de ligne ou une source d'alimentation qui ne peut pas être interrompue.

Important: Soyez sûr que rien ne repose sur les cables de l'AlterPath PM, qu'ils ne sont pas sur un lieu de passage, qu'ils ne peuvent pas être piétiné et que l'on ne peut pas trébucher dessus.

FCC Warning Statement

Important: Ne reversez pas de nourriture ou de liquides sur l'AlterPath PM. Si elle est humide, déconnectez l'alimentation électrique immédiatement et contactez Cyclades.

Important: Gardez l'AlterPath PM à distance des sources de chaleur.

FCC Warning Statement

The AlterPath PM has been tested and found to comply with the limits for Class A digital devices, pursuant to Part 15 of the FCC rules. These limits are designed to provide reasonable protection against harmful interference when the equipment is operated in a commercial environment. This equipment generates, uses, and can radiate radio frequency energy and, if not installed and used in accordance with the Installation & Service Manual, may cause harmful interference to radio communications. Operation of this equipment in a residential area is likely to cause harmful interference in which case the user is required to correct the problem at his or her own expense.

Canadian DOC Notice

The AlterPath PM does not exceed the Class A limits for radio noise emissions from digital apparatus set out in the Radio Interference Regulations of the Canadian Department of Communications.

L'AlterPath PM n'émet pas de bruits radioélectriques dépassant les limites applicables aux appareils numériques de la classe A prescrites dans le règlement sur le brouillage radioélectrique édicté par le Ministère des Communications du Canada.

Appendix C

Circuit Breakers

The PM circuit breakers are designed to shut the power off to some or all of the PM outlets in case the rated current is exceeded. The circuit breaker mechanism for each PM model is explained the in the following sections.

| | |
|-----------------------------------|----------|
| PM Units with One Circuit Breaker | Page 108 |
| PM8i and PM10i | Page 108 |
| PM10-L30A | Page 109 |
| PM10i-L30A | Page 110 |
| PM20-L30A | Page 111 |
| PM20i-L30A | Page 112 |
| Circuit Breaker Trip Time | Page 114 |

PM Units with One Circuit Breaker

Only one circuit breaker is used for the following units:

- PM8-15A
- PM8-20A
- PM8-L20
- PM10-15A
- PM10-20A
- PM10-L20
- PM20-20A
- PM20-L20
- PM20i-16A
- PM20i-20A

In the event of a current overload in any of these units, the entire unit shuts down causing all outlets to disconnect.

PM8i and PM10i

The PM8i and some versions of the PM10i (10, 15, 16, and 20 amps) have two circuit breakers each. Both circuit breakers are designed to protect different phases of the same circuit inside the unit. If either one of the two circuit breakers trips, the entire unit will shut down.

PM10-L30A

The PM10-L30A has two 15-amp circuit breakers. The first circuit breaker controls outlets 1 through 5 and the power supply to the logic board; the second circuit breaker controls outlets 6 through 10. If the total current flow to outlets 6 through 10 exceeds 15 amps due to equipment connected to these outlets, then the second circuit breaker will trip causing outlets 6 through 10 to shut down. This does not affect outlets 1 through 5, which are controlled by the first circuit breaker.

If, however, current overload causes the first circuit breaker to trip, then the entire power unit shuts down because the power supply is also tied to the first circuit breaker.

Refer to Table C-20, “Circuit Breaker Trip Time,” on page 114 to determine the time it takes for the circuit breaker to trip based on the amount of current overload.

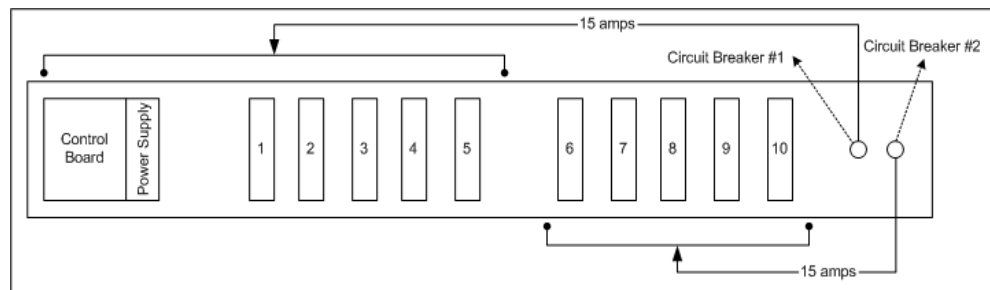

Figure C-1: PM10-L30A Circuit Breakers

PM10i-L30A

The PM10i-L30A has two 15-amp circuit breakers. The first circuit breaker controls outlets 6 through 10; the second controls outlets 1 through 5. In the event that the total current flow to outlets 6 through 10 exceeds 15 amps due to equipment connected to these outlets, the first circuit breaker will trip causing outlets 6 through 10 to shutdown. This does not affect outlets 1 through 5, which are controlled by the second circuit breaker.

As the PM10i-L30A has the controller (see Control Board in the figure below) powered from the line side of one of the circuit breakers, the whole unit will be inoperative only if both circuit breakers trip, but the controller will still function.

When either circuit breaker trips, only the power outlets of that segment will be affected, and half of the outlets remain operative.

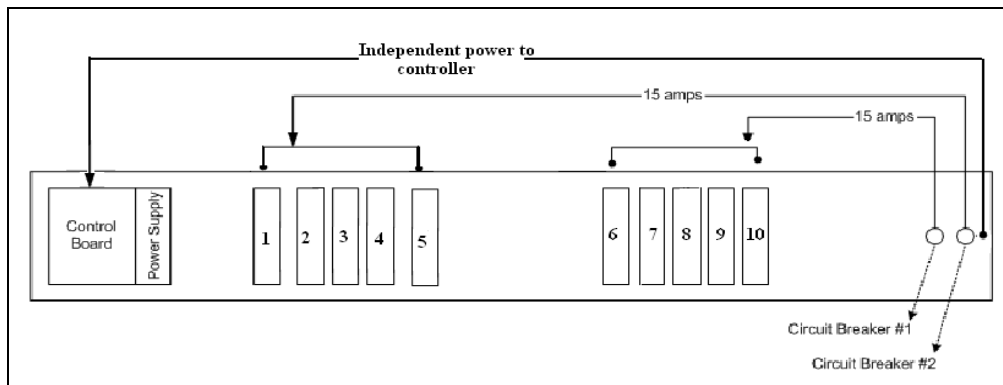

Figure C-2: PM10i-L30A Circuit Breakers

PM10i-32A and PM10i-32Au

The PM10i-32A has two 16-amp circuit breakers. The first circuit breaker controls outlets 6 through 10; the second controls outlets 1 through 5. In the event that the total current flow to outlets 6 through 10 exceeds 16 amps due to equipment connected to these outlets, the first circuit breaker will trip causing outlets 6 through 10 to shutdown. This does not affect outlets 1 through 5, which are controlled by the second circuit breaker.

As the PM10i-32A has the controller powered from the line side of one of the circuit breakers, the whole unit will be inoperative only if both circuit breakers trip, but the controller will still function.

When either circuit breaker trips, only the power outlets of that segment will be affected, and half of the outlets remain operative.

PM20-L30A

The PM20-L30A has two 15-amp circuit breakers. The first circuit breaker controls outlets 11 through 20; the second controls outlets 1 through 10 as well as the power supply to the logic board. In the event that the total current flow to outlets 11 through 20 exceeds 15 amps due to equipment connected to these outlets, then the first circuit breaker will trip causing outlets 11 through 20 to shutdown. This does not affect outlets 1 through 10 which is controlled by the second circuit breaker.

If, however, current overload causes the second circuit breaker to trip, then the entire power unit shuts down because the power supply is also tied to the second circuit breaker.

PM20i-L30A

Refer to Table C-20, “Circuit Breaker Trip Time,” on page 114 to determine the time it takes for the circuit breaker to trip based on the amount of current overload.

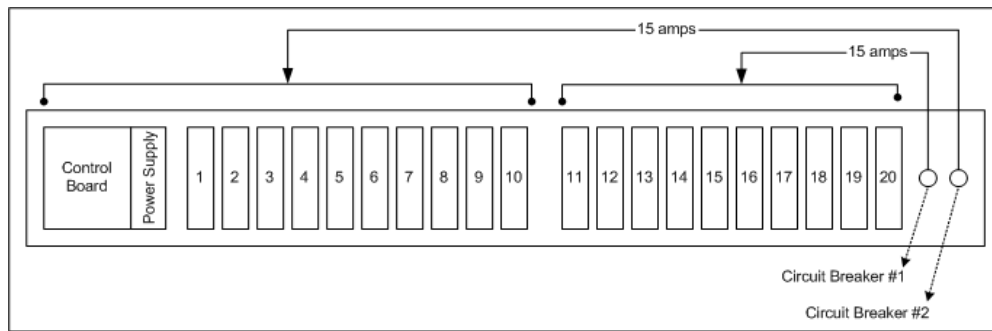

Figure C-3: PM20-L30A Circuit Breakers

PM20i-L30A

The PM20i-L30A has two 15-amp circuit breakers. The first circuit breaker controls outlets 11 through 20; the second controls outlets 1 through 10. In the event that the total current flow to outlets 11 through 20 exceeds 15 amps due to equipment connected to these outlets, then the first circuit breaker will trip causing outlets 11 through 20 to shutdown. This does not affect outlets 1 through 10 which are controlled by the second circuit breaker.

As the PM20i-L30A has the controller (see Control Board in the figure below) powered from the line side of one of the circuit breakers, the whole unit will become inoperative only when both circuit breakers trip; however, the controller will remain functioning.

When either circuit breaker trips, only the power outlets of that segment will be affected, and half of the outlets remain operative.

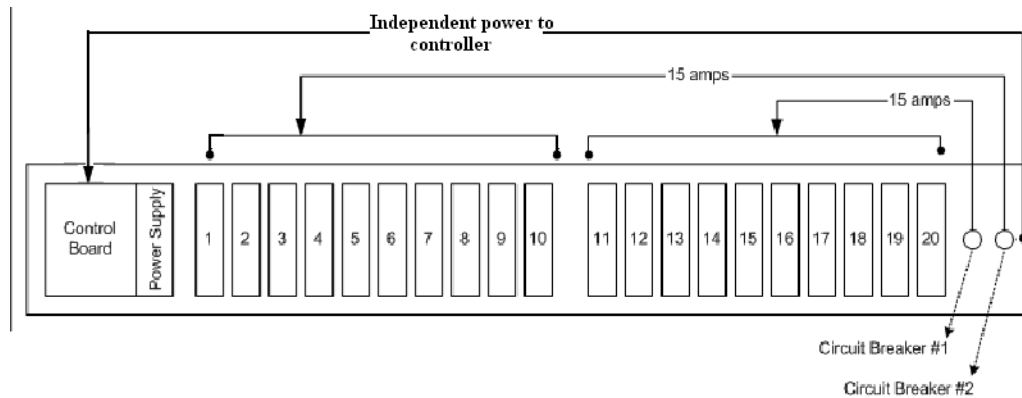

Figure C-4: PM20i-L30A Circuit Breakers

PM20i-32A and PM20i-32Au

The PM20i-32A and the PM20i-32Au have two 16-amp circuit breakers. The first circuit breaker controls outlets 11 through 20; the second controls outlets 1 through 10. In the event that the total current flow to outlets 11 through 20 exceeds 16 amps due to equipment connected to these outlets, then the first circuit breaker will trip causing outlets 11 through 20 to shutdown. This does not affect outlets 1 through 10 which are controlled by the second circuit breaker.

As the PM20i-32A and the PM20i-32Au have the controller powered from the line side of one of the circuit breakers, the whole unit will become inoperative only when both circuit breakers trip; however, the controller will remain functioning.

When either circuit breaker trips, only the power outlets of that segment will be affected, and half of the outlets remain operative.

Circuit Breaker Trip Time

Depending on the model, the AlterPath PM uses either one 10 amp, one 20 amp, two 15 amp, or two 16 amp circuit breakers. The following table shows the circuit breaker trip time for all PM models.

Table C-20: Circuit Breaker Trip Time

| Current Load | Trip Time |
|---------------------|------------------|
| 200% | 5-30 seconds |
| 300% | 1.8-10 seconds |
| 400% | 0.9-5 seconds |
| 500% | 0.5-3.3 seconds |
| 600% | 0.38-2.3 seconds |
| 800% | 0.2-1.3 seconds |
| 1000% | 0.15-0.9 seconds |

Index

A

- AC power 32
- adduser 53
- adduser command 39
- admin
 - logging in as 35
- admin password 41
- alarm 53
- alarms and monitoring 2
- AlterPath ACS 6
- AlterPath KVM 6
- AlterPath OnSite 6
- AlterPath PM
 - components 9
 - models 9
 - user interface 50
- ANSI emulation 34
- assign command 40, 54
- assigning outlets to users 40
- audience xvi
- Australia 23, 24

B

- before you begin xv
- brackets, mounting 22

- buzzer status command 55

C

- cables
 - PM10i-10A 23
- changing the default password 39
- circuit breaker
 - PM units with one 108
 - trip time 114
- circuit breakers 107
 - PM10i-L30A 110
 - PM10-L30A 109
 - PM20i-L30A 113
 - PM20-L30A 112
- command line interface 49
- commands 52
- configuration 37
 - default parameters 38
 - initial 38
 - integrated 6
 - restoring the 74
 - saving 40, 75
 - standalone 4
- console 33
 - accessing the 34
 - logging in through the 35

- console access
 - direct 8
 - through a management device 9
- console port settings 34
- Continental Europe 23, 24
- creating users 39
- current command 56
- currentprotection command 57
- Cyclades management device 7
- Cyclades-TS 6
- cycle command 58

D

- daisy chain overview 5
- daisy chaining PMs 2, 31
- Data Length 34
- DB-9 serial port 34
- default configuration parameters 38
- default password 35
- deleting users accounts 59
- deluser command 59
- document
 - audience xvi
 - CD xviii
 - downloads xviii
 - organization xvii
 - related documentation xviii
- document organization xvii
- downloading
 - documents xviii

E

- electrical and hardware specifications 83, 84
- equipment required for installation 20
- exit command 60

F

- factory_defaults command 61
- firmware upgrade 43
- flash memory 9
- Flow Control 34

H

- hardware configuration options 4
- help command 62
- HyperTerminal 4, 34

I

- In port 5, 33
 - connection 34
 - logging in through the 35
- installation 19
- installation environment 27
 - air flow 27
 - ambient temperature 27
 - circuit overloading 28
 - grounding 28
 - mechanical loading 28
 - temperature 27
- installation environment 27
- integration with Cyclades management
 - products 3
- interface pinouts 96
- interfaces 9
- interval command 65
- introduction 1
- Ireland 23, 25

K

- Kermit 4, 34

L

- list command 66
- local work station 33
- lock command 67
- logging in 35
- loopback connector 41

M

- maximum outlets supported 31
- Minicom 4, 34
- modular input power cables 22
- mounting brackets 22
- mounting the PM 29

N

- name command 40, 67
- naming outlets 40
- NEMA 5-20p 25
- NEMA 15-20p 26
- NEMA 16-20p 25
- New Zealand 23, 24

O

- off command 69
- on command 70
- organization of document xvii
- Out port 5, 31
- outlet cable package 26
- outlet name 40
- outlets
 - assigning to users 40
 - naming 40
 - plugging devices into 32
- overview, PM 2

P

- Parity 34
- part numbers 20
- passwd command 70
- pinouts, In and Out RS-232 serial ports 96
- plugging devices into outlets 32
- PM10 12
 - 15A model 86
 - 20A model 87
 - L20A model 87
 - L30A model 87, 109
- PM10i 13, 108
 - 10A model 23, 88
 - 15A model 24, 88
 - 16A model 24, 89
 - 20A model 25, 90
 - 32A model 14, 90
 - 32Au model 15, 90
 - L30A model 14, 91, 110
- PM20 15
 - 20A model 92
 - L20A model 92
 - L30A 16
 - L30A model 92, 111, 112
- PM20i 16
 - 16A model 24, 93
 - 20A model 25, 94
 - 32A model 95, 113
 - 32Au model 95, 113
 - L20A model 94
 - L30A model 94, 112, 113
- PM20i-32A 17
- PM20i-32Au 17
- PM8 10
 - 15A model 84
 - 20A model 85
 - L20A model 85

- PM8i 11, 108
 - 10A model 86
- PM8i-15A model 23
- port
 - console 34
- ports
 - In 33, 34, 35
 - Out 5, 31
- power cables
 - modular input 22
 - PM10i-10A 23
 - PM10i-15A 24
 - PM20i-16A 24
 - PM20i-20A 25
- powering on the AlterPath PM 32

R

- rack mount diagram 30
- rack mounting
 - AlterPath PM 26, 29
 - holes 29
- RAM 9
- reboot 71
- related documents xviii
- requirements, system 20
- resetting admin password 41
- restore command 74
- RJ-45 loopback connector 21
- RJ-45 serial cable 34
- RJ-45 straight-through cable 20
- RJ-45 to DB-9F adapter 34
- RJ-45 to DB-9F straight-through adapter 20, 21
- RJ-45 to RJ-45 7ft. CAT5 cable 21

S

- save command 40, 75
- save configuration 75
- sequential power up 2
- Serial Speed 34
- shipping box contents 20
- software upgrade 43
- specifications
 - PM10-15A 86
 - PM10-20A 87
 - PM10i-10A 88
 - PM10i-15A 88
 - PM10i-16A 89
 - PM10i-20A 90
 - PM10i-32A 90
 - PM10i-32Au 90
 - PM10i-L30A 91
 - PM10-L20A 87
 - PM10-L30A 87
 - PM20-20A 92
 - PM20i-16A 93
 - PM20i-20A 94
 - PM20i-32A 95
 - PM20i-32Au 95
 - PM20i-L20A 94
 - PM20i-L30A 94
 - PM20-L20A 92
 - PM20-L30A 92
 - PM8-15A 84
 - PM8-20A 85
 - PM8i-10A 86
 - PM8-L20A 85
- standalone configuration 4
- status command 76
- Stop Bits 34
- syslog command 77
- system console, accessing 8

system requirements 20

T

temperature command 78

terminal emulation program 20, 34

typographic conventions xix

U

unassign command 79

United Kingdom 23, 25

unlock command 80

upgrading PM firmware 43

US 23, 24

USB serial adapter 34

user accounts 3

users

- adding 39

- assigning outlets to 40, 54

- changing passwords of 70

- deleting 59

- unassigning outlets to 79

V

ver command 80

W

wall mounting 26

whoami command 81

